

Nevada



06.12.2023 - bis auf Widerruf

Nevada



gültig ab 06.12.2023



Emissionsgeprüft
Schadstoffgeprüft
Regelmäßige
Produkt-
überwachung

www.tuv.com
ID 1111253053



Nevada

LIEFERBARE KORPUS- UND FRONTAUSFÜHRUNGEN

Bitte geben Sie bei jeder Bestellung die exakte Farbkombination aus Front- und Korpusfarbe an!

Farbausführungen:

Korpus und Front



Griffe in Schiefer



Griffe in schwarz

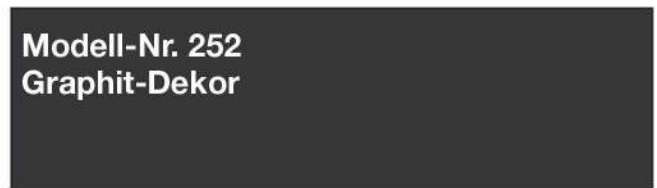

Dekorfronten

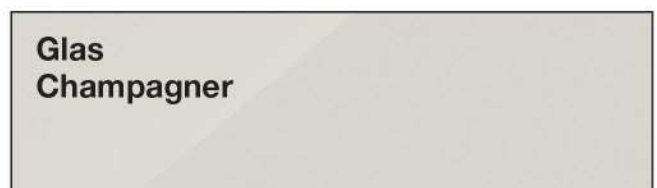
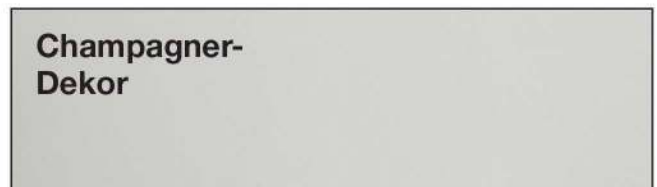
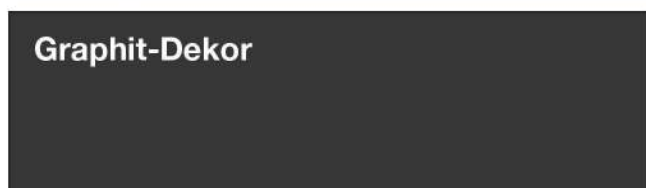

Spiegel

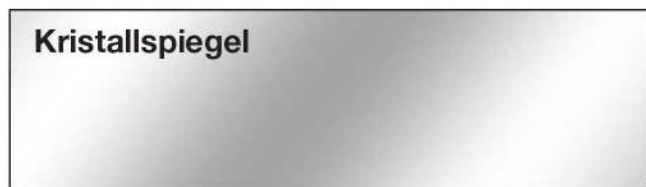

Innenfarbton



Nevada

Korpusbreiten

Drehtürenschränke

| Breite | Seite | Sockel | Seite | Sockel | Seite | Sockel | Seite | Sockel | Seite | Breite effektiv |
|--------|-------|--------|-------|--------|-------|--------|-------|--------|-------|-----------------|
| 50 | 1,5 | 47,5 | 1,5 | | | | | | | 50,5 cm |
| 100 | 1,5 | 96,4 | 1,5 | | | | | | | 99,4 cm |
| 150 | 1,5 | 96,4 | 1,5 | 47,5 | 1,5 | | | | | 148,4 cm |
| 200 | 1,5 | 96,4 | 1,5 | 96,4 | 1,5 | | | | | 197,3 cm |
| 250 | 1,5 | 96,4 | 1,5 | 47,5 | 1,5 | 96,4 | 1,5 | | | 246,3 cm |
| 300 | 1,5 | 96,4 | 1,5 | 96,4 | 1,5 | 96,4 | 1,5 | | | 295,2 cm |
| 350 | 1,5 | 96,4 | 1,5 | 96,4 | 1,5 | 47,5 | 1,5 | 96,4 | 1,5 | 344,2 cm |
| 400 | 1,5 | 96,4 | 1,5 | 96,4 | 1,5 | 96,4 | 1,5 | 96,4 | 1,5 | 393,1 cm |

Schwebetürenschränke

| Breite | Seite | Sockel | Seite | Sockel | Seite | Sockel | Seite | Sockel | Seite | Breite effektiv |
|--------|-------|--------|-------|--------|-------|--------|-------|--------|-------|-----------------|
| 150 | 1,5 | 72,2 | 1,5 | 72,2 | 1,5 | | | | | 148,9 cm |
| 200 | 1,5 | 96,4 | 1,5 | 96,4 | 1,5 | | | | | 197,3 cm |
| 225 | 1,5 | 72,2 | 1,5 | 72,2 | 1,5 | 72,2 | 1,5 | | | 222,6 cm |
| 250 | 1,5 | 80,1 | 1,5 | 80,1 | 1,5 | 80,1 | 1,5 | | | 246,3 cm |
| 280 | 1,5 | 96,4 | 1,5 | 80,1 | 1,5 | 96,4 | 1,5 | | | 278,9 cm |
| 300 | 1,5 | 96,4 | 1,5 | 96,4 | 1,5 | 96,4 | 1,5 | | | 295,2 cm |
| 300 | 1,5 | 72,2 | 1,5 | 72,2 | 1,5 | 72,2 | 1,5 | 72,2 | 1,5 | 296,3 cm |
| 330 | 1,5 | 80,1 | 1,5 | 80,1 | 1,5 | 80,1 | 1,5 | 80,1 | 1,5 | 327,9 cm |
| 400 | 1,5 | 96,4 | 1,5 | 96,4 | 1,5 | 96,4 | 1,5 | 96,4 | 1,5 | 393,1 cm |

QUALITÄT IM DETAIL

- Rückwände: Hartfaser, eingenutet
- Drehtüren mit 105°-Öffnungswinkel und gedämpften Scharnieren
- Einlegeböden: 22 mm stark, auf Metallbodenträgern
- Metall-Kleiderstangen in Metallhalterungen, 40 kg belastbar
- Alle Beschläge sind aus Metall und hoch belastbar
- Maximaler Komfort durch Lieferung montierter Beimöbel

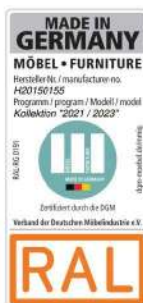

Farb- und Modellabweichungen bzw. die Korrektur von irrtümlichen Angaben behalten wir uns vor. Alle Maße sind Ca.-Maße in cm.

Nevada

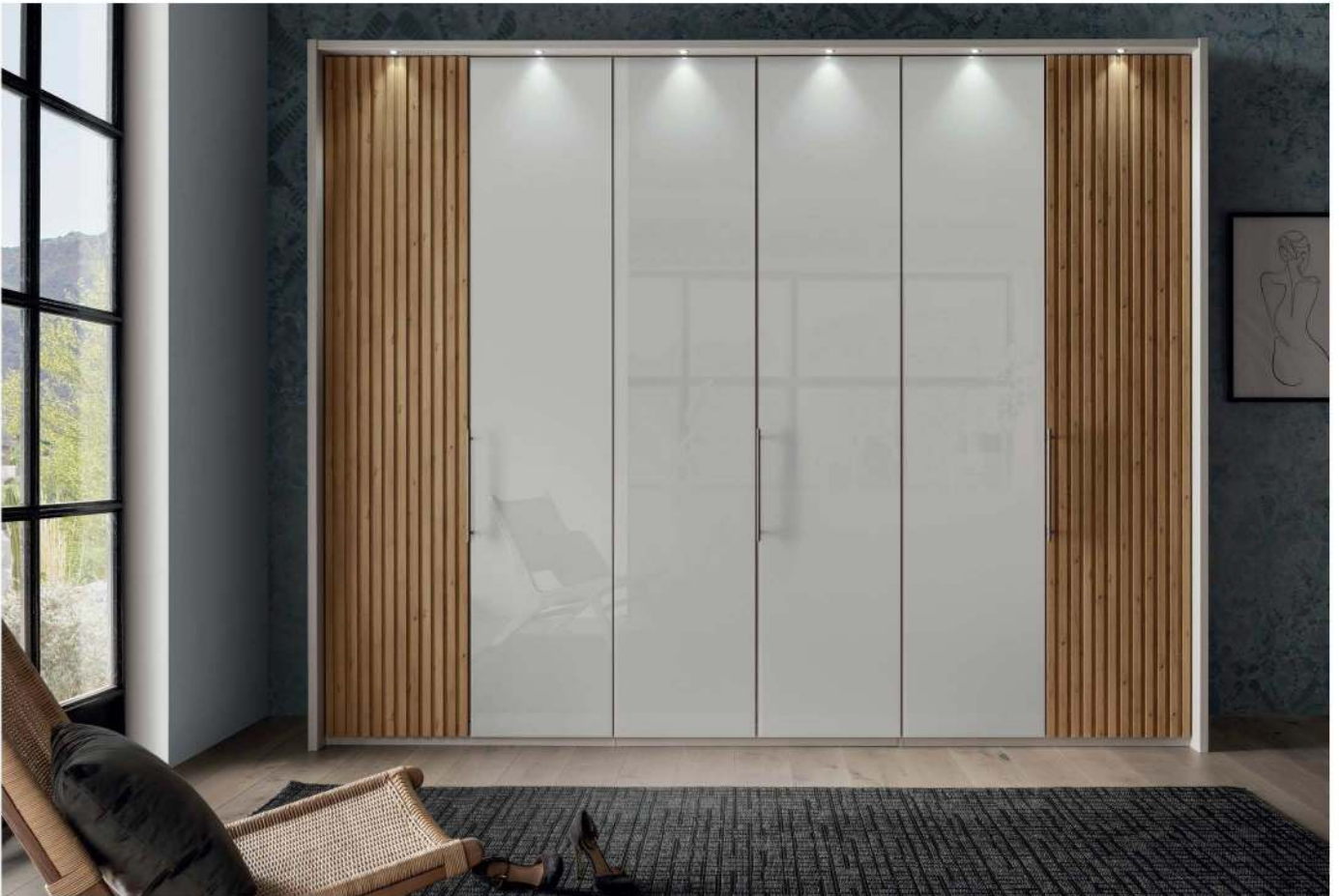

Emissionsgeprüft
Schadstoffgeprüft
Regelmäßige
Produkt-
überwachung

www.tuv.com
ID 1111253053



Nevada



Emissionsgeprüft
Schadstoffgeprüft
Regelmäßige
Produkt-
Überwachung

www.tuv.com
ID 1111253053



Nevada



gültig ab 06.12.2023



Emissionsgeprüft
Schadstoffgeprüft
Regelmäßige
Produkt-
überwachung



www.tuv.com
ID 1111253053

Nevada



gültig ab 06.12.2023



Emissionsgeprüft
Schadstoffgeprüft
Regelmäßige
Produkt-
überwachung

www.tuv.com
ID 111253053



Nevada

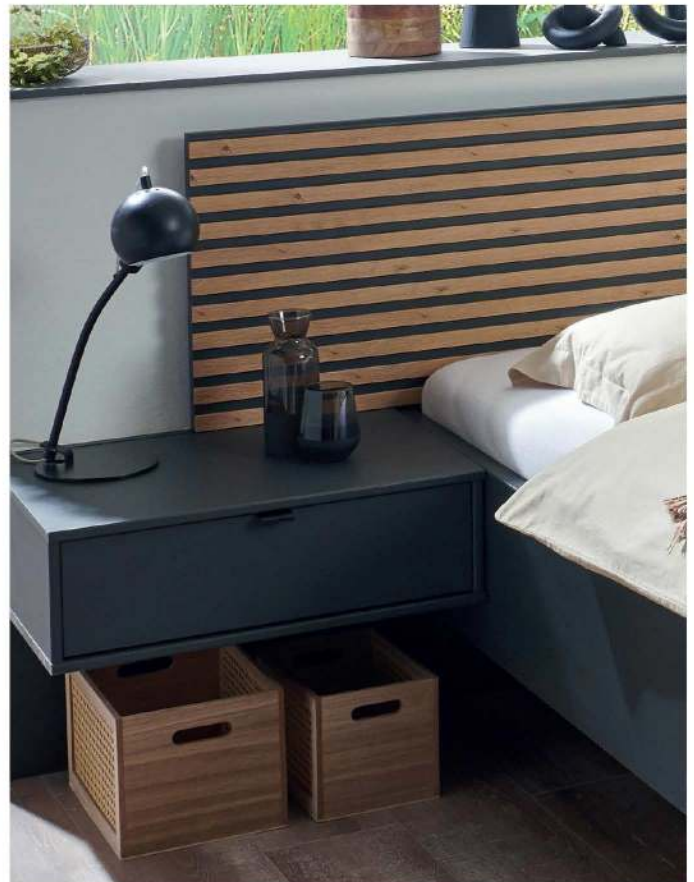

gültig ab 06.12.2023



Emissionsgeprüft
Schadstoffgeprüft
Regelmäßige
Produkt-
überwachung



www.tuv.com
ID 1111253053

Nevada



gültig ab 06.12.2023



Emissionsgeprüft
Schadstoffgeprüft
Regelmäßige
Produkt-
überwachung

www.tuv.com
ID 1111253053





Nevada

gültig ab 06.12.2023

Drehtürenschränke ohne Kranzleiste

Innenausstattung:

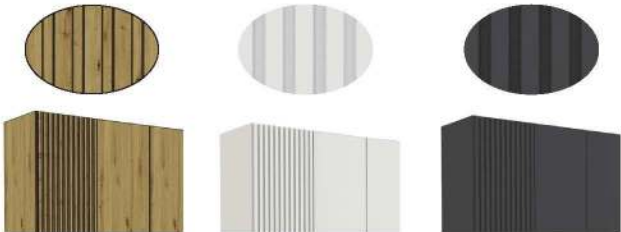
2 Einlegeböden, 1 Kleiderstange je Fach
Alle Drehtüren inkl. gedämpfter Scharniere

| Beschreibung | Maße in cm | | Höhe 216 cm | | Höhe 236 cm | |
|--|------------|----|-------------|------|-------------|------|
| | B | T | Art.-Nr. | EURO | Art.-Nr. | EURO |
|  <p>Außentüren im Korpus-Farbton mit Lamellen im Korpus-Farbton, Mitteltüren im Korpus-Farbton</p> <p>1-türig Linke Tür mit Lamellen 1-türig Rechte Tür mit Lamellen</p> <p>2-türig Linke Tür mit Lamellen 2-türig Rechte Tür mit Lamellen</p> <p>3-türig 4-türig 5-türig 6-türig 7-türig 8-türig</p> | 50 | 58 | 102 | | 128 | |
| | 50 | 58 | 103 | | 129 | |
| | 100 | 58 | 104 | | 130 | |
| | 100 | 58 | 105 | | 131 | |
| | 150 | 58 | 106 | | 132 | |
| | 200 | 58 | 107 | | 133 | |
| | 250 | 58 | 108 | | 134 | |
| | 300 | 58 | 109 | | 135 | |
| | 350 | 58 | 110 | | 136 | |
| | 400 | 58 | 111 | | 137 | |
|  <p>Modell-Nr. 234 Modell-Nr. 235 Modell-Nr. 252</p> | | | | | | |
|  <p>Außentüren im Korpus-Farbton mit Lamellen in Bianco-Eiche-NB, Mitteltüren im Korpus-Farbton</p> <p>1-türig Linke Tür mit Lamellen 1-türig Rechte Tür mit Lamellen</p> <p>2-türig Linke Tür mit Lamellen 2-türig Rechte Tür mit Lamellen</p> <p>3-türig 4-türig 5-türig 6-türig 7-türig 8-türig</p> | 50 | 58 | S01 | | S05 | |
| | 50 | 58 | S02 | | S06 | |
| | 100 | 58 | 112 | | 138 | |
| | 100 | 58 | 113 | | 139 | |
| | 150 | 58 | 114 | | 140 | |
| | 200 | 58 | 115 | | 141 | |
| | 250 | 58 | 116 | | 142 | |
| | 300 | 58 | 117 | | 143 | |
| | 350 | 58 | 118 | | 144 | |
| | 400 | 58 | 119 | | 145 | |
|  <p>Modell-Nr. 234 Modell-Nr. 235 Modell-Nr. 252</p> | | | | | | |

Nevada















gültig ab 06.12.2023

Drehtürenschränke ohne Kranzleiste

Innenausstattung:

2 Einlegeböden, 1 Kleiderstange je Fach

Alle Drehtüren inkl. gedämpfter Scharniere

| Beschreibung | Maße in cm | | Höhe 216 cm | | Höhe 236 cm | |
|---|------------|----|-------------|------|-------------|------|
| | B | T | Art.-Nr. | EURO | Art.-Nr. | EURO |
|  <p>Außentüren in Bianco-Eiche-NB mit Lamellen in Bianco-Eiche-NB, Mitteltüren im Korpus-Farbton</p> <p>1-türig Linke Tür mit Lamellen 1-türig Rechte Tür mit Lamellen</p> <p>2-türig Linke Tür mit Lamellen 2-türig Rechte Tür mit Lamellen</p> <p>3-türig 4-türig 5-türig 6-türig 7-türig 8-türig</p> | 50 | 58 | S03 | | S07 | |
| | 50 | 58 | S04 | | S08 | |
| | 100 | 58 | 120 | | 146 | |
| | 100 | 58 | 121 | | 147 | |
| | 150 | 58 | 122 | | 148 | |
| | 200 | 58 | 123 | | 149 | |
| | 250 | 58 | 124 | | 150 | |
| | 300 | 58 | 125 | | 151 | |
| | 350 | 58 | 126 | | 152 | |
| | 400 | 58 | 127 | | 153 | |
|       <p>Modell-Nr. 234 Modell-Nr. 235 Modell-Nr. 252</p> | | | | | | |
|  <p>Außentüren im Korpus-Farbton mit Lamellen im Korpus-Farbton, Mitteltüren in Champagner-Dekor</p> <p>1-türig Linke Tür mit Lamellen 1-türig Rechte Tür mit Lamellen</p> <p>2-türig Linke Tür mit Lamellen 2-türig Rechte Tür mit Lamellen</p> <p>3-türig 4-türig 5-türig 6-türig 7-türig 8-türig</p> | 50 | 58 | 102 | | 128 | |
| | 50 | 58 | 103 | | 129 | |
| | 100 | 58 | K01 | | K30 | |
| | 100 | 58 | K02 | | K31 | |
| | 150 | 58 | K03 | | K32 | |
| | 200 | 58 | K04 | | K33 | |
| | 250 | 58 | K05 | | K34 | |
| | 300 | 58 | K06 | | K35 | |
| | 350 | 58 | K07 | | K36 | |
| | 400 | 58 | K08 | | K37 | |
|       <p>Modell-Nr. 234 Modell-Nr. 235 Modell-Nr. 252</p> | | | | | | |

Nevada















gültig ab 06.12.2023

Drehtürenschränke ohne Kranzleiste

Innenausstattung:

2 Einlegeböden, 1 Kleiderstange je Fach

Alle Drehtüren inkl. gedämpfter Scharniere

| Beschreibung | Maße in cm | | Höhe 216 cm | | Höhe 236 cm | | | |
|---|---|-----|-------------|------------|-------------|------------|------------|--|
| | B | T | Art.-Nr. | EURO | Art.-Nr. | EURO | | |
|  <p>Außentüren im Korpus-Farbton mit Lamellen in Bianco-Eiche-NB, Mitteltüren in Champagner-Dekor</p> <p>1-türig Linke Tür mit Lamellen 1-türig Rechte Tür mit Lamellen</p> <p>2-türig Linke Tür mit Lamellen 2-türig Rechte Tür mit Lamellen</p> <p>3-türig 4-türig 5-türig 6-türig 7-türig 8-türig</p> <div style="display: flex; justify-content: space-around;"> <div style="text-align: center;">   Modell-Nr. 234 </div> <div style="text-align: center;">   Modell-Nr. 235 </div> <div style="text-align: center;">   Modell-Nr. 252 </div> </div> | 50 | 58 | S01 | | S05 | | | |
| | | 50 | 58 | S02 | | S06 | | |
| | | 100 | 58 | K10 | | K40 | | |
| | | 100 | 58 | K11 | | K41 | | |
| | | 150 | 58 | K12 | | K42 | | |
| | | 200 | 58 | K13 | | K43 | | |
| | | 250 | 58 | K14 | | K44 | | |
| | | 300 | 58 | K15 | | K45 | | |
| | | 350 | 58 | K16 | | K46 | | |
| | | 400 | 58 | K17 | | K47 | | |
| |  <p>Außentüren in Bianco-Eiche-NB mit Lamellen in Bianco-Eiche-NB, Mitteltüren in Champagner-Dekor</p> <p>1-türig Linke Tür mit Lamellen 1-türig Rechte Tür mit Lamellen</p> <p>2-türig Linke Tür mit Lamellen 2-türig Rechte Tür mit Lamellen</p> <p>3-türig 4-türig 5-türig 6-türig 7-türig 8-türig</p> <div style="display: flex; justify-content: space-around;"> <div style="text-align: center;">   Modell-Nr. 234 </div> <div style="text-align: center;">   Modell-Nr. 235 </div> <div style="text-align: center;">   Modell-Nr. 252 </div> </div> | 50 | 58 | S03 | | S07 | | |
| | | | 50 | 58 | S04 | | S08 | |
| | | | 100 | 58 | K20 | | K50 | |
| | | | 100 | 58 | K21 | | K51 | |
| | | | 150 | 58 | K22 | | K52 | |
| | | | 200 | 58 | K23 | | K53 | |
| | | | 250 | 58 | K24 | | K54 | |
| | | 300 | 58 | K25 | | K55 | | |
| | | 350 | 58 | K26 | | K56 | | |
| | | 400 | 58 | K27 | | K57 | | |

Nevada













gültig ab 06.12.2023

Drehtürenschränke ohne Kranzleiste

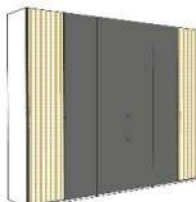
Innenausstattung:

2 Einlegeböden, 1 Kleiderstange je Fach

Alle Drehtüren inkl. gedämpfter Scharniere

| Beschreibung | Maße in cm | | Höhe 216 cm | | Höhe 236 cm | |
|---|---|----|-------------|------|-------------|------|
| | B | T | Art.-Nr. | EURO | Art.-Nr. | EURO |
|  <p>Außentüren im Korpus-Farbton mit Lamellen im Korpus-Farbton, Mitteltüren in Graphit-Dekor</p> <p>1-türig Linke Tür mit Lamellen 1-türig Rechte Tür mit Lamellen</p> <p>2-türig Linke Tür mit Lamellen 2-türig Rechte Tür mit Lamellen</p> <p>3-türig 4-türig 5-türig 6-türig 7-türig 8-türig</p> | 50 | 58 | 102 | | 128 | |
| | 50 | 58 | 103 | | 129 | |
| | 100 | 58 | 270 | | 294 | |
| | 100 | 58 | 271 | | 295 | |
| | 150 | 58 | 272 | | 296 | |
| | 200 | 58 | 273 | | 297 | |
| | 250 | 58 | 274 | | 298 | |
| | 300 | 58 | 275 | | 299 | |
| | 350 | 58 | 276 | | 300 | |
| | 400 | 58 | 277 | | 301 | |
| |       <p>Modell-Nr. 234 Modell-Nr. 235 Modell-Nr. 252</p> | | | | | |
|  <p>Außentüren im Korpus-Farbton mit Lamellen in Bianco-Eiche-NB, Mitteltüren in Graphit-Dekor</p> <p>1-türig Linke Tür mit Lamellen 1-türig Rechte Tür mit Lamellen</p> <p>2-türig Linke Tür mit Lamellen 2-türig Rechte Tür mit Lamellen</p> <p>3-türig 4-türig 5-türig 6-türig 7-türig 8-türig</p> | 50 | 58 | S01 | | S05 | |
| | 50 | 58 | S02 | | S06 | |
| | 100 | 58 | 278 | | 302 | |
| | 100 | 58 | 279 | | 303 | |
| | 150 | 58 | 280 | | 304 | |
| | 200 | 58 | 281 | | 305 | |
| | 250 | 58 | 282 | | 306 | |
| | 300 | 58 | 283 | | 307 | |
| | 350 | 58 | 284 | | 308 | |
| | 400 | 58 | 285 | | 309 | |
| |       <p>Modell-Nr. 234 Modell-Nr. 235 Modell-Nr. 252</p> | | | | | |

Nevada







gültig ab 06.12.2023

Drehtürenschränke ohne Kranzleiste

Innenausstattung:

2 Einlegeböden, 1 Kleiderstange je Fach

Alle Drehtüren inkl. gedämpfter Scharniere

| Beschreibung | Maße in cm | | Höhe 216 cm | | Höhe 236 cm | |
|--|------------|----|-------------|------|-------------|------|
| | B | T | Art.-Nr. | EURO | Art.-Nr. | EURO |
|  <p>Außentüren in Bianco-Eiche-NB mit Lamellen in Bianco-Eiche-NB, Mitteltüren in Graphit-Dekor</p> <p>1-türig Linke Tür mit Lamellen 1-türig Rechte Tür mit Lamellen</p> <p>2-türig Linke Tür mit Lamellen 2-türig Rechte Tür mit Lamellen</p> <p>3-türig 4-türig 5-türig 6-türig 7-türig 8-türig</p> | 50 | 58 | S03 | | S07 | |
| | 50 | 58 | S04 | | S08 | |
| | 100 | 58 | 286 | | 310 | |
| | 100 | 58 | 287 | | 311 | |
| | 150 | 58 | 288 | | 312 | |
| | 200 | 58 | 289 | | 313 | |
| | 250 | 58 | 290 | | 314 | |
| | 300 | 58 | 291 | | 315 | |
| | 350 | 58 | 292 | | 316 | |
| | 400 | 58 | 293 | | 317 | |
|   <p>Modell-Nr. 234 Modell-Nr. 235 Modell-Nr. 252</p> | | | | | | |
|  <p>Außentüren im Korpus-Farbton mit Lamellen im Korpus-Farbton, Mitteltüren in Glas Champagner</p> <p>1-türig Linke Tür mit Lamellen 1-türig Rechte Tür mit Lamellen</p> <p>2-türig Linke Tür mit Lamellen 2-türig Rechte Tür mit Lamellen</p> <p>3-türig 4-türig 5-türig 6-türig 7-türig 8-türig</p> | 50 | 58 | 102 | | 128 | |
| | 50 | 58 | 103 | | 129 | |
| | 100 | 58 | 206 | | 222 | |
| | 100 | 58 | 207 | | 223 | |
| | 150 | 58 | 208 | | 224 | |
| | 200 | 58 | 209 | | 225 | |
| | 250 | 58 | 210 | | 226 | |
| | 300 | 58 | 211 | | 227 | |
| | 350 | 58 | 212 | | 228 | |
| | 400 | 58 | 213 | | 229 | |
|   <p>Modell-Nr. 234 Modell-Nr. 235 Modell-Nr. 252</p> | | | | | | |

Nevada





gültig ab 06.12.2023

Drehtürenschränke ohne Kranzleiste

Innenausstattung:

2 Einlegeböden, 1 Kleiderstange je Fach

Alle Drehtüren inkl. gedämpfter Scharniere

| Beschreibung | Maße in cm | | Höhe 216 cm | | Höhe 236 cm | | |
|---|--|----|-------------|------------|-------------|------------|--|
| | B | T | Art.-Nr. | EURO | Art.-Nr. | EURO | |
|  <p>Außentüren im Korpus-Farbton mit Lamellen in Bianco-Eiche-NB, Mitteltüren in Glas Champagner</p> <p>1-türig Linke Tür mit Lamellen 1-türig Rechte Tür mit Lamellen</p> <p>2-türig Linke Tür mit Lamellen 2-türig Rechte Tür mit Lamellen</p> <p>3-türig 4-türig 5-türig 6-türig 7-türig 8-türig</p> | 50 | 58 | S01 | | S05 | | |
| | 50 | 58 | S02 | | S06 | | |
| | 100 | 58 | 214 | | 230 | | |
| | 100 | 58 | 215 | | 231 | | |
| | 150 | 58 | 216 | | 232 | | |
| | 200 | 58 | 217 | | 233 | | |
| | 250 | 58 | 218 | | 234 | | |
| | 300 | 58 | 219 | | 235 | | |
| | 350 | 58 | 220 | | 236 | | |
| | 400 | 58 | 221 | | 237 | | |
| |  <p>Modell-Nr. 234 Modell-Nr. 235 Modell-Nr. 252</p> | | | | | | |
| |  <p>Außentüren in Bianco-Eiche-NB mit Lamellen in Bianco-Eiche-NB, Mitteltüren in Glas Champagner</p> <p>1-türig Linke Tür mit Lamellen 1-türig Rechte Tür mit Lamellen</p> <p>2-türig Linke Tür mit Lamellen 2-türig Rechte Tür mit Lamellen</p> <p>3-türig 4-türig 5-türig 6-türig 7-türig 8-türig</p> | 50 | 58 | S03 | | S07 | |
| 50 | | 58 | S04 | | S08 | | |
| 100 | | 58 | 238 | | 254 | | |
| 100 | | 58 | 239 | | 255 | | |
| 150 | | 58 | 240 | | 256 | | |
| 200 | | 58 | 241 | | 257 | | |
| 250 | | 58 | 242 | | 258 | | |
| 300 | | 58 | 243 | | 259 | | |
| 350 | | 58 | 244 | | 260 | | |
| 400 | | 58 | 245 | | 261 | | |
|  <p>Modell-Nr. 234 Modell-Nr. 235 Modell-Nr. 252</p> | | | | | | | |

Nevada















gültig ab 06.12.2023

Drehtürenschränke ohne Kranzleiste

Innenausstattung:

2 Einlegeböden, 1 Kleiderstange je Fach

Alle Drehtüren inkl. gedämpfter Scharniere

| Beschreibung | Maße in cm | | Höhe 216 cm | | Höhe 236 cm | | |
|---|---|----|-------------|------------|-------------|------------|--|
| | B | T | Art.-Nr. | EURO | Art.-Nr. | EURO | |
|  <p>Außentüren im Korpus-Farbtön mit Lamellen im Korpus-Farbtön, Mitteltüren in Kristallspiegel</p> <p>1-türig Linke Tür mit Lamellen 1-türig Rechte Tür mit Lamellen</p> <p>2-türig Linke Tür mit Lamellen 2-türig Rechte Tür mit Lamellen</p> <p>3-türig 4-türig 5-türig 6-türig 7-türig 8-türig</p> <div style="display: flex; justify-content: space-around;"> <div style="text-align: center;">   Modell-Nr. 234 </div> <div style="text-align: center;">   Modell-Nr. 235 </div> <div style="text-align: center;">   Modell-Nr. 252 </div> </div> | 50 | 58 | 102 | | 128 | | |
| | 50 | 58 | 103 | | 129 | | |
| | 100 | 58 | 156 | | 182 | | |
| | 100 | 58 | 157 | | 183 | | |
| | 150 | 58 | 158 | | 184 | | |
| | 200 | 58 | 159 | | 185 | | |
| | 250 | 58 | 160 | | 186 | | |
| | 300 | 58 | 161 | | 187 | | |
| | 350 | 58 | 162 | | 188 | | |
| | 400 | 58 | 163 | | 189 | | |
| |  <p>Außentüren im Korpus-Farbtön mit Lamellen in Bianco-Eiche-NB, Mitteltüren in Kristallspiegel</p> <p>1-türig Linke Tür mit Lamellen 1-türig Rechte Tür mit Lamellen</p> <p>2-türig Linke Tür mit Lamellen 2-türig Rechte Tür mit Lamellen</p> <p>3-türig 4-türig 5-türig 6-türig 7-türig 8-türig</p> <div style="display: flex; justify-content: space-around;"> <div style="text-align: center;">   Modell-Nr. 234 </div> <div style="text-align: center;">   Modell-Nr. 235 </div> <div style="text-align: center;">   Modell-Nr. 252 </div> </div> | 50 | 58 | S01 | | S05 | |
| | | 50 | 58 | S02 | | S06 | |
| 100 | | 58 | 164 | | 190 | | |
| 100 | | 58 | 165 | | 191 | | |
| 150 | | 58 | 166 | | 192 | | |
| 200 | | 58 | 167 | | 193 | | |
| 250 | | 58 | 168 | | 194 | | |
| 300 | | 58 | 169 | | 195 | | |
| 350 | | 58 | 170 | | 196 | | |
| 400 | | 58 | 171 | | 197 | | |

Innenausstattungs Pakete für Drehtürenschränke

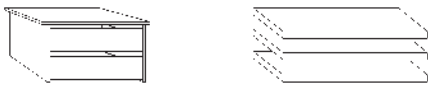
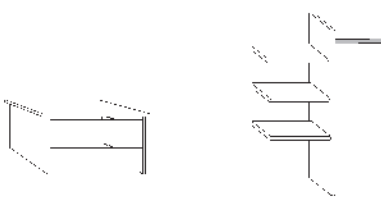

Innenausführung: Streifendekor silber-grau

| Beschreibung | Maße in cm | | | Art.-Nr. | EURO |
|--|------------|---|---|------------|------|
| | B | H | T | | |
| <p>Für Schränke mit Sockelkombination 96,4 cm und 47,5 cm</p> <ul style="list-style-type: none"> - 073 Schubkasten-Einsatz, 2 Auszüge, Holzfront, B 96,4 cm - 031 3-er Set Einlegeböden B 47,5 cm | 1 | 1 | 1 | IN1 | |
|  | | | | | |
| <p>Für Schränke mit Sockelkombination 96,4 cm und 96,4 cm</p> <ul style="list-style-type: none"> - 073 Schubkasten-Einsatz, 2 Auszüge, Holzfront, B 96,4 cm - 066 Wäscheboden-Einsatz B 96,4 cm | 1 | 1 | 1 | IN2 | |
|  | | | | | |



Weiteres Zubehör finden Sie auf den Seiten 32-37.

Passepartout-Rahmen für Drehtürenschränke im Korpus-Farbtone mit oder ohne Beleuchtung

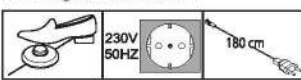



| Beschreibung | Maße in cm | | Höhe 216 cm | | Höhe 236 cm | | |
|--|---|-------|-------------|------------|-------------|------------|--|
| | B | T | Art.-Nr. | EURO | Art.-Nr. | EURO | |
|  <p>Ohne Beleuchtung, Breite je Seitenstollen: 3,2 cm</p> <ul style="list-style-type: none"> - für Schrankbreite 50 cm - für Schrankbreite 100 cm - für Schrankbreite 150 cm - für Schrankbreite 200 cm - für Schrankbreite 250 cm - für Schrankbreite 300 cm - für Schrankbreite 350 cm - für Schrankbreite 400 cm <p>Draufsicht Schrank inkl. PPT-Rahmen</p> <p>Maße in cm</p> | 56,4 | 12,5 | 900 | | 930 | | |
| | 106,4 | 12,5 | 901 | | 931 | | |
| | 156,4 | 12,5 | 902 | | 932 | | |
| | 206,4 | 12,5 | 903 | | 933 | | |
| | 256,4 | 12,5 | 904 | | 934 | | |
| | 306,4 | 12,5 | 905 | | 935 | | |
| | 356,4 | 12,5 | 906 | | 936 | | |
| | 406,4 | 12,5 | 907 | | 937 | | |
| |  <p>Aufpreis für umlaufende LED-Beleuchtung (optional):</p> <ul style="list-style-type: none"> - für Schrankbreite 50 cm - für Schrankbreite 100 cm - für Schrankbreite 150 cm - für Schrankbreite 200 cm - für Schrankbreite 250 cm - für Schrankbreite 300 cm - für Schrankbreite 350 cm - für Schrankbreite 400 cm <p>Dieses Produkt enthält Lichtquellen der Energieeffizienzklasse F</p>  | 56,4 | 12,5 | 910 | | 940 | |
| | | 106,4 | 12,5 | 911 | | 941 | |
| 156,4 | | 12,5 | 912 | | 942 | | |
| 206,4 | | 12,5 | 913 | | 943 | | |
| 256,4 | | 12,5 | 914 | | 944 | | |
| 306,4 | | 12,5 | 915 | | 945 | | |
| 356,4 | | 12,5 | 916 | | 946 | | |
| 406,4 | | 12,5 | 917 | | 947 | | |

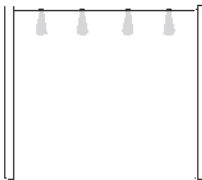
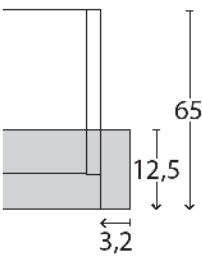

Bitte beachten:

Bei Verwendung eines Passepartout-Rahmens verbreitert sich der Schrank auf die ausgewiesenen Maße.

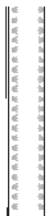



Passepartout-Rahmen für Drehtürenschränke im Korpus-Farbtone mit Beleuchtung

| Beschreibung | Maße in cm | | Höhe 216 cm | | Höhe 236 cm | |
|--|------------|---|-------------|------|-------------|------|
| | B | T | Art.-Nr. | EURO | Art.-Nr. | EURO |
|  <p>Mit LED-Beleuchtung, Breite je Seitenstollen: 3,2 cm</p> <p>1 Leuchte - für Schrankbreite 50 cm 2 Leuchten - für Schrankbreite 100 cm 3 Leuchten - für Schrankbreite 150 cm 4 Leuchten - für Schrankbreite 200 cm 5 Leuchten - für Schrankbreite 250 cm 6 Leuchten - für Schrankbreite 300 cm 7 Leuchten - für Schrankbreite 350 cm 8 Leuchten - für Schrankbreite 400 cm</p> <p>Draufsicht Schrank inkl. PPT-Rahmen</p>  <p>Maße in cm</p> <p>Dieses Produkt enthält Lichtquellen der Energieeffizienzklasse F</p>  | | | | | | |
| <p>Stollenbeleuchtung</p>  <p>Nicht nachträglich einbaubar! Für Seitenstollen und Passepartout-Rahmen ohne umlaufende Beleuchtung verwendbar!</p> <p>Dieses Produkt enthält Lichtquellen der Energieeffizienzklasse F</p>  | 1,5 | 1 | 082 | | 083 | |

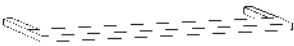
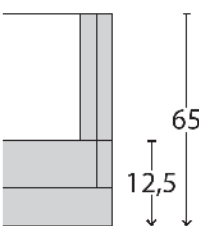

Bitte beachten:
Bei Verwendung eines Passepartout-Rahmens verbreitert sich der Schrank auf die ausgewiesenen Maße.

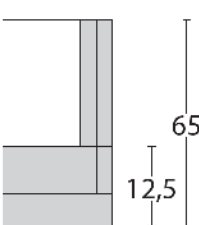
Kranzleisten für Drehtürenschränke im Korpus-Farbton mit oder ohne Beleuchtung



| Beschreibung | Maße in cm | | | Art.-Nr. | EURO |
|---|------------|---|---|----------|------|
| | B | H | T | | |
|  <p>Kranzleiste, ohne Beleuchtung</p> <p>- für Schrankbreite 50 cm</p> <p>- für Schrankbreite 100 cm</p> <p>- für Schrankbreite 150 cm</p> <p>- für Schrankbreite 200 cm</p> <p>- für Schrankbreite 250 cm</p> <p>- für Schrankbreite 300 cm</p> <p>- für Schrankbreite 350 cm</p> <p>- für Schrankbreite 400 cm</p> | | | | | |
| <p>Draufsicht Schrank inkl. Kranzleiste</p>  <p>Maße in cm</p> | | | | | |
|  <p>Mit LED-Beleuchtung</p> <p>1 Leuchte - für Schrankbreite 50 cm</p> <p>2 Leuchten - für Schrankbreite 100 cm</p> <p>3 Leuchten - für Schrankbreite 150 cm</p> <p>4 Leuchten - für Schrankbreite 200 cm</p> <p>5 Leuchten - für Schrankbreite 250 cm</p> <p>6 Leuchten - für Schrankbreite 300 cm</p> <p>7 Leuchten - für Schrankbreite 350 cm</p> <p>8 Leuchten - für Schrankbreite 400 cm</p> | | | | | |
| <p>Draufsicht Schrank inkl. Kranzleiste</p>  <p>Maße in cm</p> | | | | | |
| <p>Dieses Produkt enthält Lichtquellen der Energieeffizienzklasse F</p>  | | | | | |

Nevada





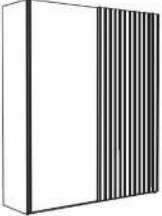
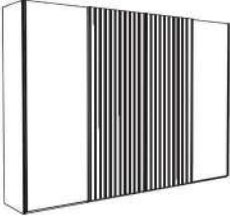

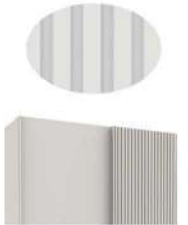
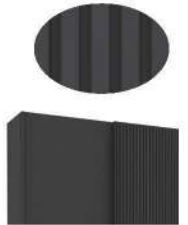



















gültig ab 06.12.2023

Schwebetürenschränke Griffeleisten im Korpus-Farbton

Innenausstattung:
2 Einlegeböden, 1 Kleiderstange

| Beschreibung | Maße in cm | | Höhe 217 cm | | Höhe 236 cm | |
|--|--|--|-------------|------|-------------|------|
| | B | T | Art.-Nr. | EURO | Art.-Nr. | EURO |
|  <p>Front im Korpus-Farbton, mittlere Tür(en) im Korpus-Farbton mit Lamellen im Korpus-Farbton</p> <p>2-türig 1 Lamellentür rechts</p> <p>2-türig 1 Lamellentür rechts</p> <p>3-türig 1 Lamellentür mittig</p> <p>3-türig 1 Lamellentür mittig</p> <p>3-türig 1 Lamellentür mittig</p> <p>3-türig 1 Lamellentür mittig</p> | 150 | 67 | 370 | | 379 | |
| | 200 | 67 | 371 | | 380 | |
| | 225 | 67 | 372 | | 381 | |
| | 250 | 67 | 373 | | 382 | |
| | 280 | 67 | 374 | | 383 | |
| | 300 | 67 | 375 | | 384 | |
|  <p>- mit Synchronöffnung</p> <p>4-türig 2 Lamellentüren mittig</p> <p>4-türig 2 Lamellentüren mittig</p> <p>4-türig 2 Lamellentüren mittig</p> | 300 | 67 | 376 | | 385 | |
| | 330 | 67 | 377 | | 386 | |
| | 400 | 67 | 378 | | 387 | |
| | | | | | | |
|  <p>Modell-Nr. 234</p> |  <p>Modell-Nr. 235</p> |  <p>Modell-Nr. 252</p> | | | | |

Sockel-Aufteilung



| | | | | | | | | | | | | |
|---|---|---|---|---|---|---|---|---|---|---|---|---|
|  |  |  |  |  |  |  |  |  |  |  |  |  |
| 150 cm | 200 cm | 225 cm | 250 cm | 280 cm | 300 cm | 300 cm | 330 cm | 400 cm | | | | |
|  |  |  |  |  |  |  |  |  |  |  |  |  |
| 300 cm | 300 cm | 330 cm | 400 cm | | | | | | | | | |

Nevada

gültig ab 06.12.2023

Schwebetürenschränke Griffleisten im Korpus-Farbton

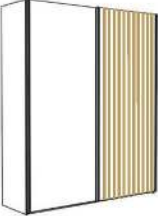
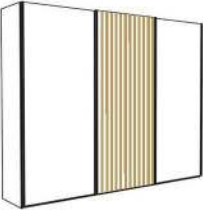
Innenausstattung:
2 Einlegeböden, 1 Kleiderstange

| Beschreibung | Maße in cm | | Höhe 217 cm | | Höhe 236 cm | |
|---|------------|------------------------|-------------|------|-------------|------------|
| | B | T | Art.-Nr. | EURO | Art.-Nr. | EURO |
|  <p>Front im Korpus-Farbton, mittlere Tür(en) im Korpus-Farbton mit Lamellen in Bianco-Eiche-NB</p> | 2-türig | 1 Lamellentür rechts | 150 | 67 | 388 | 397 |
| | 2-türig | 1 Lamellentür rechts | 200 | 67 | 389 | 398 |
| | 3-türig | 1 Lamellentür mittig | 225 | 67 | 390 | 399 |
| | 3-türig | 1 Lamellentür mittig | 250 | 67 | 391 | 400 |
| | 3-türig | 1 Lamellentür mittig | 280 | 67 | 392 | 401 |
| | 3-türig | 1 Lamellentür mittig | 300 | 67 | 393 | 402 |
|  <p>- mit Synchronöffnung</p> | 4-türig | 2 Lamellentüren mittig | 300 | 67 | 394 | 403 |
| | 4-türig | 2 Lamellentüren mittig | 330 | 67 | 395 | 404 |
| | 4-türig | 2 Lamellentüren mittig | 400 | 67 | 396 | 405 |
| | | | | | | |
|  <p>Modell-Nr. 234 Modell-Nr. 235 Modell-Nr. 252</p> | | | | | | |

Sockel-Aufteilung

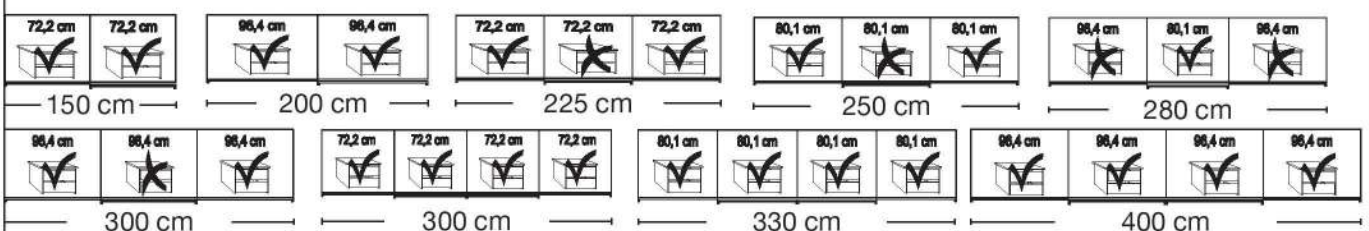







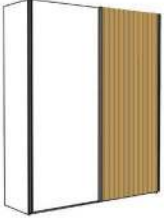

Nevada

gültig ab 06.12.2023

Schwebetürenschränke Griffleisten im Korpus-Farbton

Innenausstattung:
2 Einlegeböden, 1 Kleiderstange

| Beschreibung | Maße in cm | | Höhe 217 cm | | Höhe 236 cm | |
|---|---|---|-------------|------|-------------|------------|
| | B | T | Art.-Nr. | EURO | Art.-Nr. | EURO |
|  <p>Front im Korpus-Farbton, mittlere Tür(en) in Bianco- Eiche-NB mit Lamellen in Bianco-Eiche-NB</p> | 2-türig | 1 Lamellentür rechts | 150 | 67 | 406 | 415 |
| | 2-türig | 1 Lamellentür rechts | 200 | 67 | 407 | 416 |
| | 3-türig | 1 Lamellentür mittig | 225 | 67 | 408 | 417 |
| | 3-türig | 1 Lamellentür mittig | 250 | 67 | 409 | 418 |
| | 3-türig | 1 Lamellentür mittig | 280 | 67 | 410 | 419 |
| | 3-türig | 1 Lamellentür mittig | 300 | 67 | 411 | 420 |
|  <p>- mit Synchronöffnung</p> | 4-türig | 2 Lamellentüren mittig | 300 | 67 | 412 | 421 |
| | 4-türig | 2 Lamellentüren mittig | 330 | 67 | 413 | 422 |
| | 4-türig | 2 Lamellentüren mittig | 400 | 67 | 414 | 423 |
|   <p>Modell-Nr. 234</p> |   <p>Modell-Nr. 235</p> |   <p>Modell-Nr. 252</p> | | | | |

Sockel-Aufteilung

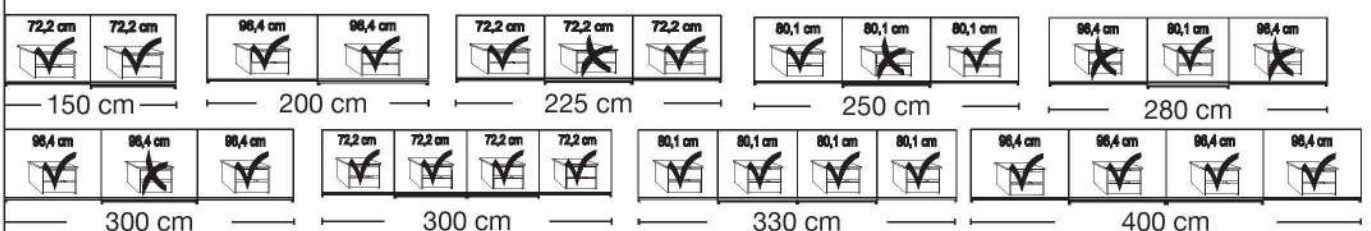







Nevada

gültig ab 06.12.2023

Schwebetürenschränke Griffeleisten im Korpus-Farbton

Innenausstattung:
2 Einlegeböden, 1 Kleiderstange

| Beschreibung | Maße in cm | | Höhe 217 cm | | Höhe 236 cm | | |
|--|---|--|--|------|-------------|------|--|
| | B | T | Art.-Nr. | EURO | Art.-Nr. | EURO | |
|  <p>Front in Champagner-Dekor, mittlere Tür(en) im Korpus- Farbton mit Lamellen im Korpus-Farbton</p> | 2-türig | 1 Lamellentür rechts | 150 | 67 | 532 | 541 | |
| | 2-türig | 1 Lamellentür rechts | 200 | 67 | 533 | 542 | |
| | 3-türig | 1 Lamellentür mittig | 225 | 67 | 534 | 543 | |
| | 3-türig | 1 Lamellentür mittig | 250 | 67 | 535 | 544 | |
| | 3-türig | 1 Lamellentür mittig | 280 | 67 | 536 | 545 | |
| | 3-türig | 1 Lamellentür mittig | 300 | 67 | 537 | 546 | |
|  <p>- mit Synchronöffnung</p> | 4-türig | 2 Lamellentüren mittig | 300 | 67 | 538 | 547 | |
| | 4-türig | 2 Lamellentüren mittig | 330 | 67 | 539 | 548 | |
| | 4-türig | 2 Lamellentüren mittig | 400 | 67 | 540 | 549 | |
|  |  <p>Modell-Nr. 234</p> |  <p>Modell-Nr. 235</p> |  <p>Modell-Nr. 252</p> | | | | |

Sockel-Aufteilung

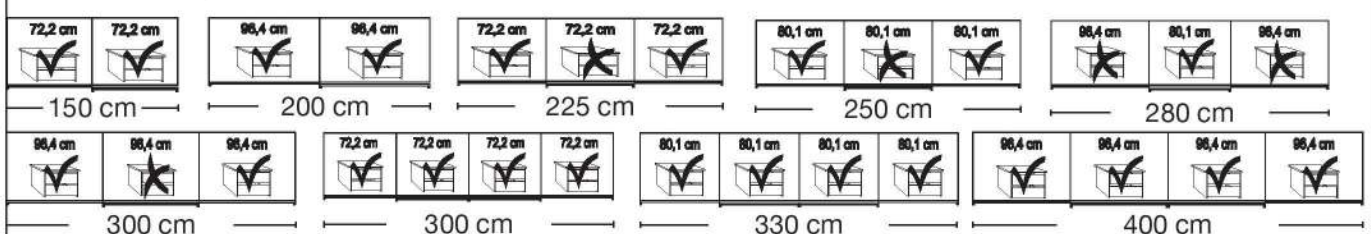





Nevada





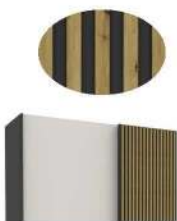

gültig ab 06.12.2023

Schwebetürenschränke Griffeleisten im Korpus-Farbton

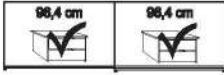
Innenausstattung:
2 Einlegeböden, 1 Kleiderstange

| Beschreibung | Maße in cm | | Höhe 217 cm | | Höhe 236 cm | | |
|---|--------------------------------|-----|-------------|------|-------------|------|--|
| | B | T | Art.-Nr. | EURO | Art.-Nr. | EURO | |
|       | 2-türig 1 Lamellentür rechts | 150 | 67 | 550 | | 559 | |
| | 2-türig 1 Lamellentür rechts | 200 | 67 | 551 | | 560 | |
| | 3-türig 1 Lamellentür mittig | 225 | 67 | 552 | | 561 | |
| | 3-türig 1 Lamellentür mittig | 250 | 67 | 553 | | 562 | |
| | 3-türig 1 Lamellentür mittig | 280 | 67 | 554 | | 563 | |
| | 3-türig 1 Lamellentür mittig | 300 | 67 | 555 | | 564 | |
| | - mit Synchronöffnung | | | | | | |
| | 4-türig 2 Lamellentüren mittig | 300 | 67 | 556 | | 565 | |
| | 4-türig 2 Lamellentüren mittig | 330 | 67 | 557 | | 566 | |
| | 4-türig 2 Lamellentüren mittig | 400 | 67 | 558 | | 567 | |

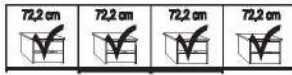
Sockel-Aufteilung

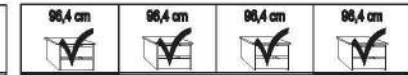







| | | | | |
|---|---|--|---|---|
|  |  |  |  |  |
| 150 cm | 200 cm | 225 cm | 250 cm | 280 cm |
|  |  |  |  | |
| 300 cm | 300 cm | 330 cm | 400 cm | |

Nevada

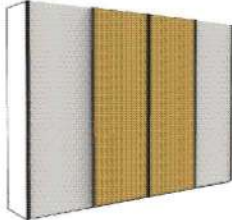
gültig ab 06.12.2023

Schwebetürenschränke Griffeleisten im Korpus-Farbton

Innenausstattung:
2 Einlegeböden, 1 Kleiderstange

| Beschreibung | Maße in cm | | Höhe 217 cm | | Höhe 236 cm | |
|---|---|---|-------------|------|-------------|------------|
| | B | T | Art.-Nr. | EURO | Art.-Nr. | EURO |
|  <p>Front in Champagner-Dekor, mittlere Tür(en) in Bianco- Eiche-NB mit Lamellen in Bianco-Eiche-NB</p> | 2-türig | 1 Lamellentür rechts | 150 | 67 | 568 | 577 |
| | 2-türig | 1 Lamellentür rechts | 200 | 67 | 569 | 578 |
| | 3-türig | 1 Lamellentür mittig | 225 | 67 | 570 | 579 |
| | 3-türig | 1 Lamellentür mittig | 250 | 67 | 571 | 580 |
| | 3-türig | 1 Lamellentür mittig | 280 | 67 | 572 | 581 |
| | 3-türig | 1 Lamellentür mittig | 300 | 67 | 573 | 582 |
|  <p>- mit Synchronöffnung</p> | 4-türig | 2 Lamellentüren mittig | 300 | 67 | 574 | 583 |
| | 4-türig | 2 Lamellentüren mittig | 330 | 67 | 575 | 584 |
| | 4-türig | 2 Lamellentüren mittig | 400 | 67 | 576 | 585 |
| |  | | | | | |
|   <p>Modell-Nr. 234</p> |   <p>Modell-Nr. 235</p> |   <p>Modell-Nr. 252</p> | | | | |

Sockel-Aufteilung

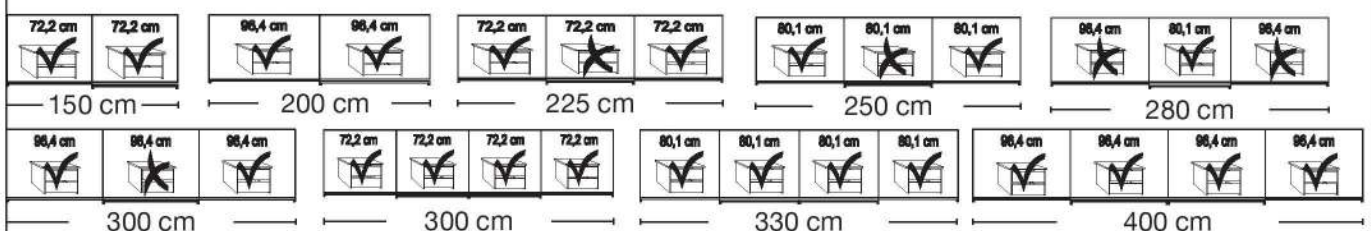





Nevada

gültig ab 06.12.2023

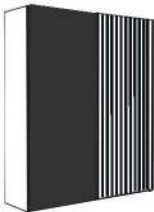
Schwebetürenschränke Griffeleisten im Korpus-Farbton

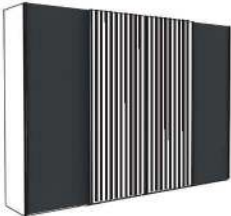
Innenausstattung:
2 Einlegeböden, 1 Kleiderstange

| Beschreibung | Maße in cm | | Höhe 217 cm | | Höhe 236 cm | |
|--|---|--------------------------|-------------|------|-------------|------|
| | B | T | Art.-Nr. | EURO | Art.-Nr. | EURO |
|      | Front in Graphit-Dekor, mittlere Tür(en) im Korpus- Farbton mit Lamellen im Korpus-Farbton | | | | | |
| | 2-türig 1 Lamellentür rechts | 150 | 67 | 478 | | 487 |
| | 2-türig 1 Lamellentür rechts | 200 | 67 | 479 | | 488 |
| | 3-türig 1 Lamellentür mittig | 225 | 67 | 480 | | 489 |
| | 3-türig 1 Lamellentür mittig | 250 | 67 | 481 | | 490 |
| | 3-türig 1 Lamellentür mittig | 280 | 67 | 482 | | 491 |
| | 3-türig 1 Lamellentür mittig | 300 | 67 | 483 | | 492 |
| | - mit Synchronöffnung | | | | | |
| | 4-türig 2 Lamellentüren mittig | 300 | 67 | 484 | | 493 |
| | 4-türig 2 Lamellentüren mittig | 330 | 67 | 485 | | 494 |
| 4-türig 2 Lamellentüren mittig | 400 | 67 | 486 | | 495 | |
| Modell-Nr. 234 | Modell-Nr. 235 | Modell-Nr. 252 | | | | |

Sockel-Aufteilung

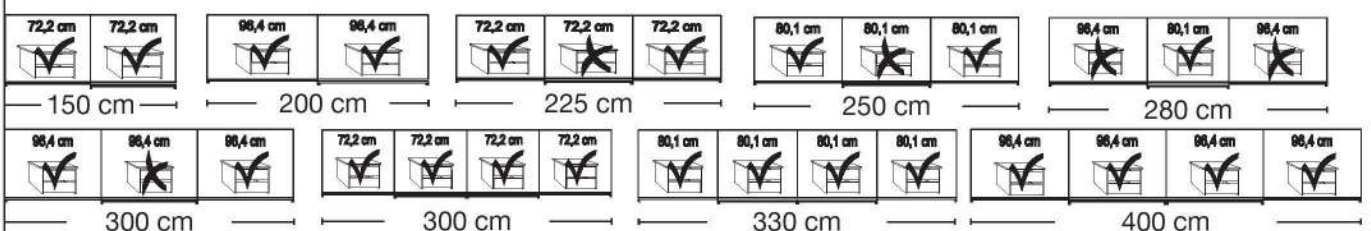





Nevada

gültig ab 06.12.2023

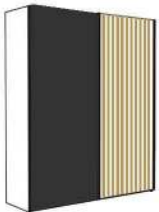
Schwebetürenschränke Griffleisten im Korpus-Farbton

Innenausstattung:
2 Einlegeböden, 1 Kleiderstange

| Beschreibung | Maße in cm | | Höhe 217 cm | | Höhe 236 cm | | |
|--|---|-----------------------|-------------|------|-------------|------|--|
| | B | T | Art.-Nr. | EURO | Art.-Nr. | EURO | |
|     | Front in Graphit-Dekor, mittlere Tür(en) im Korpus-Farbton mit Lamellen in Bianco-Eiche-NB | | | | | | |
| | 2-türig 1 Lamellentür rechts | 150 | 67 | 496 | | 505 | |
| | 2-türig 1 Lamellentür rechts | 200 | 67 | 497 | | 506 | |
| | 3-türig 1 Lamellentür mittig | 225 | 67 | 498 | | 507 | |
| | 3-türig 1 Lamellentür mittig | 250 | 67 | 499 | | 508 | |
| | 3-türig 1 Lamellentür mittig | 280 | 67 | 500 | | 509 | |
| | 3-türig 1 Lamellentür mittig | 300 | 67 | 501 | | 510 | |
| | - mit Synchronöffnung | | | | | | |
| | 4-türig 2 Lamellentüren mittig | 300 | 67 | 502 | | 511 | |
| | 4-türig 2 Lamellentüren mittig | 330 | 67 | 503 | | 512 | |
| 4-türig 2 Lamellentüren mittig | 400 | 67 | 504 | | 513 | | |
| Modell-Nr. 234 | Modell-Nr. 235 | Modell-Nr. 252 | | | | | |

Sockel-Aufteilung

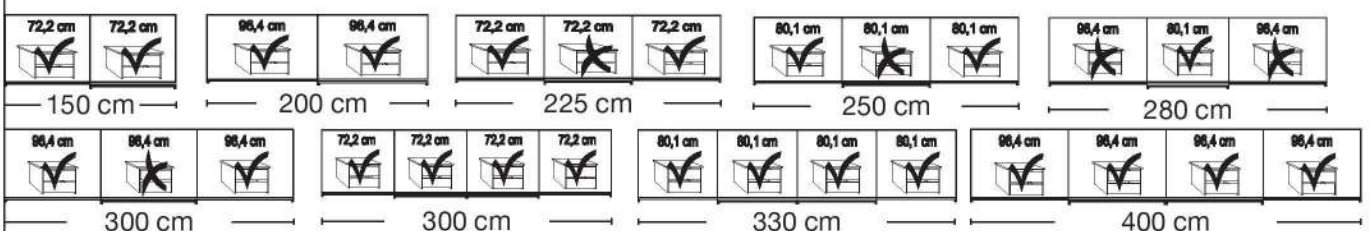







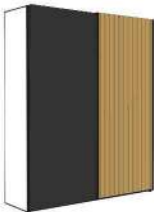

Nevada

gültig ab 06.12.2023

Schwebetürenschränke Griffleisten im Korpus-Farbton

Innenausstattung:
2 Einlegeböden, 1 Kleiderstange

| Beschreibung | Maße in cm | | Höhe 217 cm | | Höhe 236 cm | | |
|--|---|---|-------------|------|-------------|------------|--|
| | B | T | Art.-Nr. | EURO | Art.-Nr. | EURO | |
| Front in Graphit-Dekor, mittlere Tür(en) in Bianco-Eiche-NB mit Lamellen in Bianco-Eiche-NB | | | | | | | |
|  | 2-türig | 1 Lamellentür rechts | 150 | 67 | 514 | 523 | |
| | 2-türig | 1 Lamellentür rechts | 200 | 67 | 515 | 524 | |
| | 3-türig | 1 Lamellentür mittig | 225 | 67 | 516 | 525 | |
| | 3-türig | 1 Lamellentür mittig | 250 | 67 | 517 | 526 | |
| | 3-türig | 1 Lamellentür mittig | 280 | 67 | 518 | 527 | |
| | 3-türig | 1 Lamellentür mittig | 300 | 67 | 519 | 528 | |
|  | - mit Synchronöffnung | | | | | | |
| | 4-türig | 2 Lamellentüren mittig | 300 | 67 | 520 | 529 | |
| | 4-türig | 2 Lamellentüren mittig | 330 | 67 | 521 | 530 | |
| | 4-türig | 2 Lamellentüren mittig | 400 | 67 | 522 | 531 | |
| |  | | | | | | |
| | | | | | | | |
| | | | | | | | |
|  |  |  | | | | | |
|  |  |  | | | | | |
| Modell-Nr. 234 | Modell-Nr. 235 | Modell-Nr. 252 | | | | | |

Sockel-Aufteilung

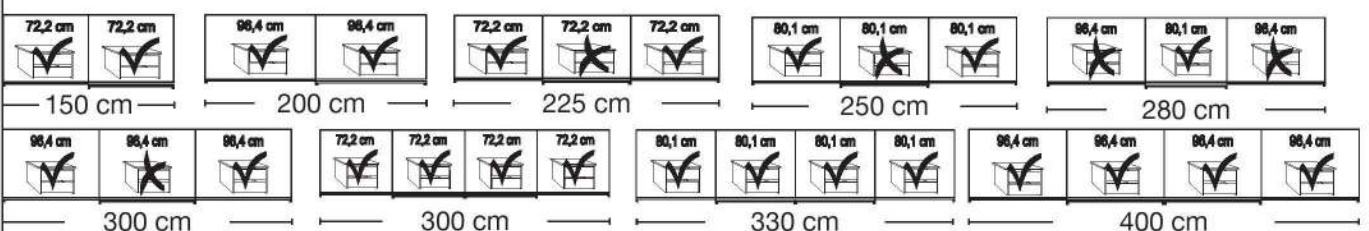



Nevada

gültig ab 06.12.2023

Schwebetürenschränke Griffeleisten im Korpus-Farbton

Innenausstattung:
2 Einlegeböden, 1 Kleiderstange

| Beschreibung | Maße in cm | | Höhe 217 cm | | Höhe 236 cm | |
|--|------------|------------------------|-------------|------|-------------|------|
| | B | T | Art.-Nr. | EURO | Art.-Nr. | EURO |
| Front in Glas Champagner, mittlere Tür(en) im Korpus-Farbton mit Lamellen im Korpus-Farbton | | | | | | |
|  | 2-türig | 1 Lamellentür rechts | 150 | 67 | 424 | 433 |
| | 2-türig | 1 Lamellentür rechts | 200 | 67 | 425 | 434 |
|  | 3-türig | 1 Lamellentür mittig | 225 | 67 | 426 | 435 |
| | 3-türig | 1 Lamellentür mittig | 250 | 67 | 427 | 436 |
| | 3-türig | 1 Lamellentür mittig | 280 | 67 | 428 | 437 |
| | 3-türig | 1 Lamellentür mittig | 300 | 67 | 429 | 438 |
| - mit Synchronöffnung | | | | | | |
|  | 4-türig | 2 Lamellentüren mittig | 300 | 67 | 430 | 439 |
| | 4-türig | 2 Lamellentüren mittig | 330 | 67 | 431 | 440 |
| | 4-türig | 2 Lamellentüren mittig | 400 | 67 | 432 | 441 |

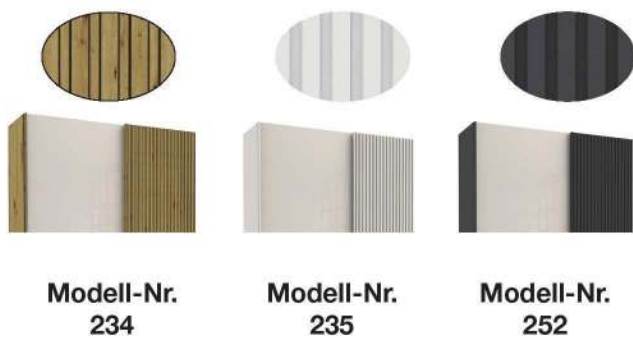

Modell-Nr.
234

Modell-Nr.
235

Modell-Nr.
252

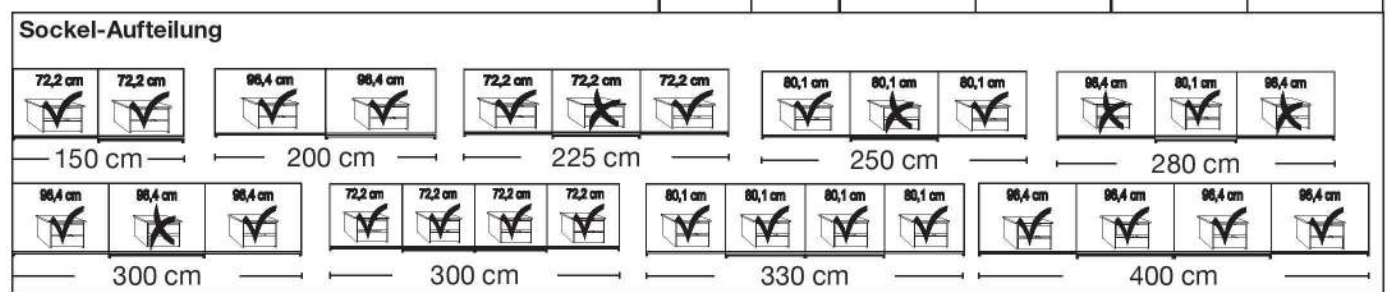









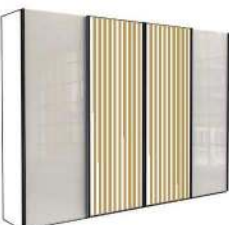

Nevada

gültig ab 06.12.2023

Schwebetürenschränke Griffeleisten im Korpus-Farbton

Innenausstattung:
2 Einlegeböden, 1 Kleiderstange

| Beschreibung | Maße in cm | | Höhe 217 cm | | Höhe 236 cm | |
|---|---|---|-------------|---|-------------|------|
| | B | T | Art.-Nr. | EURO | Art.-Nr. | EURO |
| Front in Glas Champagner, mittlere Tür(en) im Korpus-Farbton mit Lamellen in Bianco-Eiche-NB | | | | | | |
|  | 2-türig | 1 Lamellentür rechts | 150 | 67 | 442 | 451 |
| | 2-türig | 1 Lamellentür rechts | 200 | 67 | 443 | 452 |
| | 3-türig | 1 Lamellentür mittig | 225 | 67 | 444 | 453 |
| | 3-türig | 1 Lamellentür mittig | 250 | 67 | 445 | 454 |
| | 3-türig | 1 Lamellentür mittig | 280 | 67 | 446 | 455 |
| | 3-türig | 1 Lamellentür mittig | 300 | 67 | 447 | 456 |
|  | - mit Synchronöffnung | | | | | |
| | 4-türig | 2 Lamellentüren mittig | 300 | 67 | 448 | 457 |
| | 4-türig | 2 Lamellentüren mittig | 330 | 67 | 449 | 458 |
| | 4-türig | 2 Lamellentüren mittig | 400 | 67 | 450 | 459 |
| |  | | | | | |
| |  | | | | | |
|  | |  | |  | | |
|  | |  | |  | | |
| Modell-Nr. 234 | | Modell-Nr. 235 | | Modell-Nr. 252 | | |

Sockel-Aufteilung

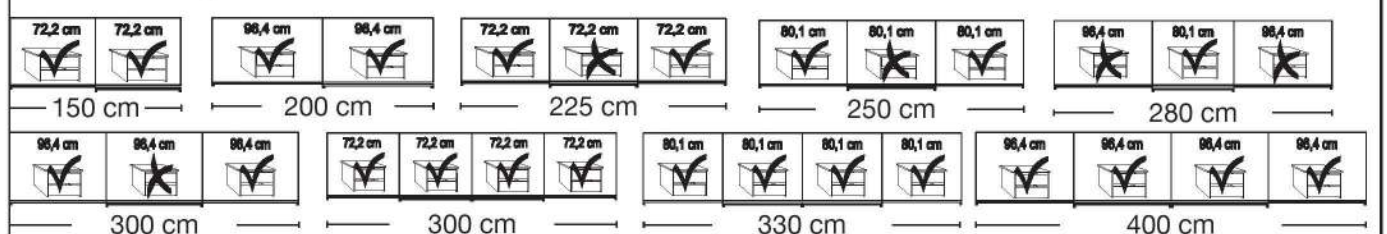





Nevada

gültig ab 06.12.2023

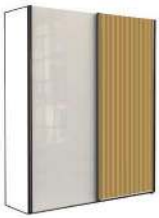
Schwebetürenschränke Griffleisten im Korpus-Farbton

Innenausstattung:
2 Einlegeböden, 1 Kleiderstange



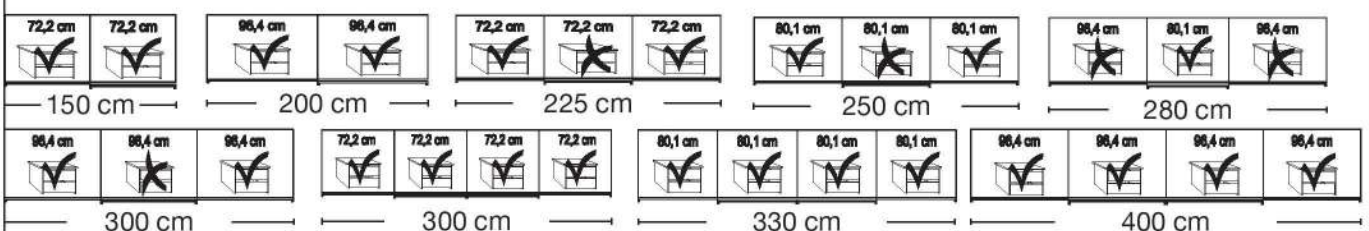

| Beschreibung | Maße in cm | | Höhe 217 cm | | Höhe 236 cm | | |
|--|--|---------------------------|---------------------------|------------|-------------|------------|--|
| | B | T | Art.-Nr. | EURO | Art.-Nr. | EURO | |
|      | Front in Glas Champagner, mittlere Tür(en) in Bianco-Eiche- NB mit Lamellen in Bianco- Eiche-NB | | | | | | |
| | 2-türig 1 Lamellentür rechts | 150 | 67 | 460 | | 469 | |
| | 2-türig 1 Lamellentür rechts | 200 | 67 | 461 | | 470 | |
| | 3-türig 1 Lamellentür mittig | 225 | 67 | 462 | | 471 | |
| | 3-türig 1 Lamellentür mittig | 250 | 67 | 463 | | 472 | |
| | 3-türig 1 Lamellentür mittig | 280 | 67 | 464 | | 473 | |
| | 3-türig 1 Lamellentür mittig | 300 | 67 | 465 | | 474 | |
| | - mit Synchronöffnung | | | | | | |
| | 4-türig 2 Lamellentüren mittig | 300 | 67 | 466 | | 475 | |
| | 4-türig 2 Lamellentüren mittig | 330 | 67 | 467 | | 476 | |
| | 4-türig 2 Lamellentüren mittig | 400 | 67 | 468 | | 477 | |
| | Modell-Nr. 234 | Modell-Nr. 235 | Modell-Nr. 252 | | | | |

Sockel-Aufteilung



Innenausstattungspakete für Schwebetürenschränke

Innenausführung: Streifendekor silber-grau

| Beschreibung | Maße in cm | | | Art.-Nr. | EURO |
|--|------------|---|---|------------|------|
| | B | H | T | | |
| <p>Für Schrankbreite 150 und 300 (4-türig) cm:</p> <ul style="list-style-type: none"> - 368 Selbsteinzug mit Dämpfung für Außentüren - 071 Schubkasten-Einsatz, 2 Auszüge, Holzfront, B 72,2 cm - 025 Wäscheboden-Einsatz B 72,2 cm  | 1 | 1 | 1 | C40 | |
| <p>Für Schrankbreite 250 und 330 cm:</p> <ul style="list-style-type: none"> - 368 Selbsteinzug mit Dämpfung für Außentüren - 072 Schubkasten-Einsatz, 2 Auszüge, Holzfront, B 80,1 cm - 026 Wäscheboden-Einsatz B 80,1 cm  | 1 | 1 | 1 | C41 | |
| <p>Für Schrankbreite 200, 300 (3-türig) und 400 cm:</p> <ul style="list-style-type: none"> - 368 Selbsteinzug mit Dämpfung für Außentüren - 073 Schubkasten-Einsatz, 2 Auszüge, Holzfront, B 96,4 cm - 066 Wäscheboden-Einsatz B 96,4 cm  | 1 | 1 | 1 | C42 | |
| <p>Für Schrankbreite 280 cm:</p> <ul style="list-style-type: none"> - 368 Selbsteinzug mit Dämpfung für Außentüren - 072 Schubkasten-Einsatz, 2 Auszüge, Holzfront, B 80,1 cm - 066 Wäscheboden-Einsatz B 96,4 cm  | 1 | 1 | 1 | C43 | |



Weiteres Zubehör finden Sie auf den Seiten 32-37.

Passepartout-Rahmen für Schwebetürenschränke im Korpus-Farbton mit oder ohne Beleuchtung

| Beschreibung | Maße in cm | | Höhe 221 cm | | Höhe 240 cm | | |
|--|--|------------|-------------|------------|-------------|------|--|
| | B | T | Art.-Nr. | EURO | Art.-Nr. | EURO | |
|  <p>Passepartout-Rahmen, Breite je Seitenstollen: 5 cm ohne Beleuchtung</p> <ul style="list-style-type: none"> - für Schrankbreite 150 cm - für Schrankbreite 200 cm - für Schrankbreite 225 cm - für Schrankbreite 250 cm - für Schrankbreite 280 cm - für Schrankbreite 300 cm - für Schrankbreite 300 cm - für Schrankbreite 330 cm - für Schrankbreite 400 cm <p>Maße in cm</p> | 160 | 23 | 700 | | 709 | | |
| | 210 | 23 | 701 | | 710 | | |
| | 235 | 23 | 702 | | 711 | | |
| | 260 | 23 | 703 | | 712 | | |
| | 290 | 23 | 704 | | 713 | | |
| | 310 | 23 | 705 | | 714 | | |
| | 310 | 23 | 706 | | 715 | | |
| | 340 | 23 | 707 | | 716 | | |
| | 410 | 23 | 708 | | 717 | | |
| | <p>Aufpreis für umlaufende LED-Beleuchtung (optional):</p> <ul style="list-style-type: none"> - für Schrankbreite 150 cm - für Schrankbreite 200 cm - für Schrankbreite 225 cm - für Schrankbreite 250 cm - für Schrankbreite 280 cm - für Schrankbreite 300 cm - für Schrankbreite 300 cm - für Schrankbreite 330 cm - für Schrankbreite 400 cm | | | | | | |
| | 160 | 23 | 737 | | 746 | | |
| | 210 | 23 | 738 | | 747 | | |
| 235 | 23 | 739 | | 748 | | | |
| 260 | 23 | 740 | | 749 | | | |
| 290 | 23 | 741 | | 750 | | | |
| 310 | 23 | 742 | | 751 | | | |
| 310 | 23 | 743 | | 752 | | | |
| 340 | 23 | 744 | | 753 | | | |
| 410 | 23 | 745 | | 754 | | | |

Dieses Produkt enthält Lichtquellen der Energieeffizienzklasse F

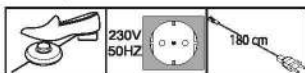





Nicht nachträglich einbaubar!



Bitte beachten:

Bei Verwendung eines Passepartout-Rahmens verbreitert sich der Schrank auf die ausgewiesenen Maße.

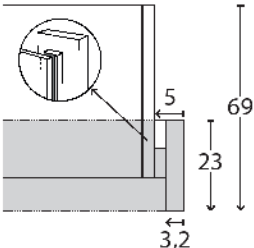
Passepartout-Rahmen für Schwebetürenschränke im Korpus-Farbton mit Beleuchtung

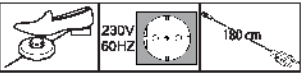
| Beschreibung | Maße in cm | | Höhe 221 cm | | Höhe 240 cm | |
|--|------------|----|-------------|------|-------------|------|
| | B | T | Art.-Nr. | EURO | Art.-Nr. | EURO |
|  <p>Passepartout-Rahmen, Breite je Seitenstollen: 5 cm mit Beleuchtung</p> | | | | | | |
| 2 Leuchten - für Schrankbreite 150 cm | 160 | 23 | 718 | | 727 | |
| 4 Leuchten - für Schrankbreite 200 cm | 210 | 23 | 719 | | 728 | |
| 6 Leuchten - für Schrankbreite 225 cm | 235 | 23 | 720 | | 729 | |
| 6 Leuchten - für Schrankbreite 250 cm | 260 | 23 | 721 | | 730 | |
| 6 Leuchten - für Schrankbreite 280 cm | 290 | 23 | 722 | | 731 | |
| 6 Leuchten - für Schrankbreite 300 cm | 310 | 23 | 723 | | 732 | |
|  - nur für 3-türige Schränke | | | | | | |
| 8 Leuchten - für Schrankbreite 300 cm | 310 | 23 | 724 | | 733 | |
|  - nur für 4-türige Schränke | | | | | | |
| 8 Leuchten - für Schrankbreite 330 cm | 340 | 23 | 725 | | 734 | |
| 8 Leuchten - für Schrankbreite 400 cm | 410 | 23 | 726 | | 736 | |
| <p>Draufsicht Schrank inkl. PPT-Rahmen</p>  <p>Maße in cm</p> <p>Dieses Produkt enthält Lichtquellen der Energieeffizienzklasse F</p>  | | | | | | |
| <p>Stollenbeleuchtung</p>  <p>Nicht nachträglich einbaubar!</p> <p>Für Seitenstollen und Passepartout-Rahmen ohne umlaufende Beleuchtung verwendbar!</p> <p>Dieses Produkt enthält Lichtquellen der Energieeffizienzklasse F</p>  | 1,5 | 1 | 084 | | 085 | |



Bitte beachten:

Bei Verwendung eines Passepartout-Rahmens verbreitert sich der Schrank auf die ausgewiesenen Maße.



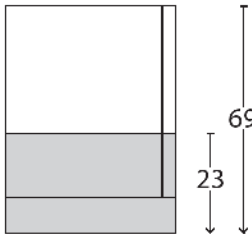
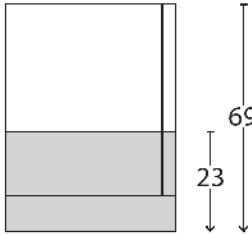

Kranzleisten für Schwebetürenschränke im Korpus-Farbton mit oder ohne Beleuchtung

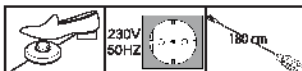
| Beschreibung | Maße in cm | | | Art.-Nr. | EURO |
|---|------------|---|----|------------|------|
| | B | H | T | | |
|  <p>Kranzleiste, ohne Beleuchtung</p> <ul style="list-style-type: none"> - für Schrankbreite 150 cm - für Schrankbreite 200 cm - für Schrankbreite 225 cm - für Schrankbreite 250 cm - für Schrankbreite 280 cm <p>Draufsicht Schrank inkl. Kranzleiste</p>  <p>Maße in cm</p> <ul style="list-style-type: none"> - für Schrankbreite 300 cm ⚠ - nur für 3-türige Schränke | 150 | 5 | 23 | 986 | |
| | 200 | 5 | 23 | 987 | |
| | 225 | 5 | 23 | 988 | |
| | 250 | 5 | 23 | 989 | |
| | 280 | 5 | 23 | 990 | |
| | 300 | 5 | 23 | 991 | |
| | 300 | 5 | 23 | 992 | |
| | 330 | 5 | 23 | 993 | |
| | 400 | 5 | 23 | 994 | |
| <p>Mit LED-Beleuchtung</p> <ul style="list-style-type: none"> 2 Leuchten - für Schrankbreite 150 cm 4 Leuchten - für Schrankbreite 200 cm 6 Leuchten - für Schrankbreite 225 cm 6 Leuchten - für Schrankbreite 250 cm 6 Leuchten - für Schrankbreite 280 cm <p>Draufsicht Schrank inkl. Kranzleiste</p>  <p>Maße in cm</p> <ul style="list-style-type: none"> 6 Leuchten - für Schrankbreite 300 cm ⚠ - nur für 3-türige Schränke | 150 | 5 | 23 | 995 | |
| | 200 | 5 | 23 | 996 | |
| | 225 | 5 | 23 | 997 | |
| | 250 | 5 | 23 | 998 | |
| | 280 | 5 | 23 | 999 | |
| | 300 | 5 | 23 | 926 | |
| | 300 | 5 | 23 | 927 | |
| | 330 | 5 | 23 | 928 | |
| | 400 | 5 | 23 | 929 | |







Dieses Produkt enthält Lichtquellen der Energieeffizienzklasse F



Schrank-Zubehör





| Beschreibung | Maße in cm | | | Art.-Nr. | EURO |
|---|------------|---|----|------------|------|
| | B | H | T | | |
|  <p>LED-Line-Vorbauleuchte, flach in schwarz</p> <p>1 Stück 2 Stück 3 Stück</p> <p>Dieses Produkt enthält Lichtquellen der Energieeffizienzklasse E</p>  <p>Nur in Verbindung mit Passepartout-Rahmen und Kranzleisten!</p> | 60 | 6 | 19 | 880 | |
| | 60 | 6 | 19 | 881 | |
| | 60 | 6 | 19 | 882 | |
|  <p>LED-Line-Aufbauleuchte in schwarz</p> <p>1 Stück 2 Stück 3 Stück</p> <p>Dieses Produkt enthält Lichtquellen der Energieeffizienzklasse E</p>  | 60 | 6 | 19 | 883 | |
| | 60 | 6 | 19 | 884 | |
| | 60 | 6 | 19 | 885 | |
| | | | | | |

Zusatzelemente für Schwebetürenschränke

| | Beschreibung | Maße in cm | | | Art.-Nr. | EURO |
|---|---|------------|---|----|------------|------|
| | | B | H | T | | |
|  | Kollisionsdämpfer - für 2-türige Schränke 1 Stück  Optimale Funktion nur in Verbindung mit Außentürdämpfung | 28 | 4 | 2 | 369 | |
| | - für 3-4-türige Schränke 2 Stück  Optimale Funktion nur in Verbindung mit Außen- und Mitteltürdämpfung! | 28 | 4 | 2 | 012 | |
|  | Selbsteinzug mit Dämpfung für Mitteltüren - für 3-türige Schränke * Stück - für 4-türige Schränke Stück  * Bitte Deckenhöhe beachten! Montage kann nur von der Schrank-Oberseite erfolgen! | 24 | 2 | 11 | 366 | |
| | | 24 | 2 | 11 | 367 | |
|  | 2-er Set Selbsteinzug mit Dämpfung für Außentüren, Set für 2-,3-, und 4-türige Schränke Paar | 24 | 2 | 11 | 368 | |



Schrank-Zubehör

Innenausführung: Streifendekor silber-grau

| | Beschreibung | Maße in cm | | | Art.-Nr. | EURO |
|--|---|------------|---|---|----------|------|
| | | B | H | T | | |
|  | 1 Einlegeboden - für Fachbreite 47,5 cm 1 Stück - für Fachbreite 72,2 cm 1 Stück - für Fachbreite 80,1 cm 1 Stück - für Fachbreite 96,4 cm 1 Stück | | | | | |
|  | 3 Einlegeböden - für Fachbreite 47,5 cm 3 Stück - für Fachbreite 72,2 cm 3 Stück - für Fachbreite 80,1 cm 3 Stück - für Fachbreite 96,4 cm 3 Stück | | | | | |
|  Dieses Produkt enthält eine Lichtquelle der Energieeffizienzklasse F | LED-Lichtblende für Einlegeböden - für Fachbreite 47,5 cm 1 Stück - für Fachbreite 72,2 cm 1 Stück - für Fachbreite 80,1 cm 1 Stück - für Fachbreite 96,4 cm 1 Stück - für Fachbreite 47,5 cm 2 Stück - für Fachbreite 72,2 cm 2 Stück - für Fachbreite 80,1 cm 2 Stück - für Fachbreite 96,4 cm 2 Stück - für Fachbreite 47,5 cm 3 Stück - für Fachbreite 72,2 cm 3 Stück - für Fachbreite 80,1 cm 3 Stück - für Fachbreite 96,4 cm 3 Stück | | | | | |
|  | Kleiderstange - für Fachbreite 47,5 cm 1 Stück - für Fachbreite 72,2 cm 1 Stück - für Fachbreite 80,1 cm 1 Stück - für Fachbreite 96,4 cm 1 Stück | | | | | |

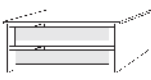
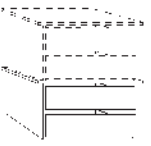
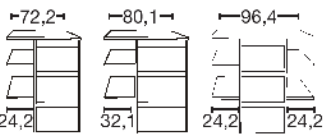

Schrank-Zubehör

Innenausführung: Streifendekor silber-grau

| | Beschreibung | Maße in cm | | | Art.-Nr. | EURO |
|--|--|----------------------|-------------------|----------------------|--|------|
| | | B | H | T | | |
|  | <p>Schubkasten-Einsatz mit 2 Auszügen und GLASfront für Drehtüren- und Schwebetürenschränke</p> <ul style="list-style-type: none"> - für Fachbreite 72,2 cm - für Fachbreite 80,1 cm - für Fachbreite 96,4 cm | 72,2 80,1 96,4 | 41 41 41 | 52 52 52 | 068 069 070 | |
|  | <p>Schubkasten-Einsatz mit 2 Auszügen und HOLZfront für Drehtüren- und Schwebetürenschränke, stapelbar und auf beliebiger Höhe einbaubar</p> <ul style="list-style-type: none"> - für Fachbreite 72,2 cm - für Fachbreite 80,1 cm - für Fachbreite 96,4 cm | 72,2 80,1 96,4 | 41 41 41 | 44 44 44 | 071 072 073 | |
|  <p>Art.-Nr. 023 Art.-Nr. 024 Art.-Nr. 064</p> | <p>Schubkasten-Einsatz mit 3 Auszügen mit Selbsteinzug und HOLZfront</p> <ul style="list-style-type: none"> - für Fachbreite 72,2 cm - für Fachbreite 80,1 cm - für Fachbreite 96,4 cm | 72,2 80,1 96,4 | 89 89 89 | 51,5 51,5 51,5 | 023 024 064 | |
|  | <p>Wäscheboden-Einsatz, bestehend aus:</p> <p>3 Einlegeböden, 1 Kleiderstange, 1 Mittelseite</p> <ul style="list-style-type: none"> - für Fachbreite 72,2 cm - für Fachbreite 80,1 cm - für Fachbreite 96,4 cm | 72,2 80,1 96,4 | 137 137 137 | 51,5 51,5 51,5 | 025 026 066 | |
|  | <p>Beidseitig (links- oder rechtsseitig) verwendbar!</p> <p>Nur auf Sockelböden stellbar!</p> | | | | | |



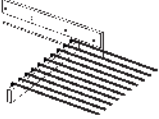
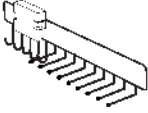
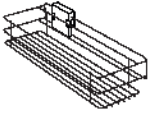
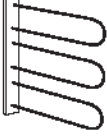
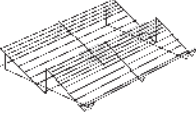

Schrank-Zubehör

Innenausführung: Streifendekor silber-grau

| Beschreibung | Maße in cm | | | Art.-Nr. | EURO |
|--|------------|----|----|------------|------|
| | B | H | T | | |
|  <p>Ausziehbarer Hosenhalter</p> | 45 | 10 | 50 | 056 | |
|  <p>Krawatten- und Gürtelauszug</p> | 7 | 19 | 45 | 059 | |
|  <p>Utensilien-Auszug</p> | 16 | 9 | 45 | 076 | |
|  <p>Krawatten- und Gürtelhalter</p> | 30 | 27 | 9 | 042 | |
|  <p>Schuhrost für Schrankfach B 96,4 cm - für Fachbreite 96,4 cm</p> | 96 | 15 | 50 | 093 | |
|  <p>Kleiderlift für Schrankfach-Breite 72,2 - 96,4 cm</p> | 100 | 85 | 14 | 081 | |
| | | | | | |

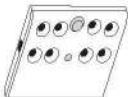
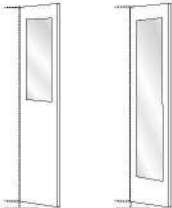
Schrank-Zubehör

Innenausführung: Streifendekor silber-grau

| Beschreibung | Maße in cm | | | Art.-Nr. | EURO |
|--|----------------------|------------------|----------------------|--|------|
| | B | H | T | | |
|  <p>LED-Schrankinnenbeleuchtung mit Bewegungsmelder, inkl. Akku (Ladevorgang über USB)</p> <p>1 Stück 2 Stück 3 Stück 4 Stück</p> | 10 10 10 10 | 2 2 2 2 | 10 10 10 10 | 006 007 008 009 | |
|  <p>Innenspiegel</p> <p> Nur in Verbindung mit Drehtürenschränken!</p> <p>Art.-Nr. 046 Art.-Nr. 047</p> | 36 36 | 80 173 | 1 1 | 046 047 | |
|  <p>Innenspiegel, ausklappbar</p> <p> Nur in Verbindung mit Schwebetürenschränken!</p> <p> Nicht in Verbindung mit LED-Lichtblende verwendbar!</p> | 36 | 173 | 2 | 080 | |





Nevada

gültig ab 06.12.2023

Betten

Bettseiten-Höhe 48 cm

Liegehöhen-Verstellung 4-fach

| Beschreibung | Liegefläche in cm | Stellfläche in cm | Art.-Nr. | EURO |
|--|--|--|--|------|
|  <p>Überstehendes Paneel im Korpus-Farbtone mit Lamellen im Korpus-Farbtone ohne Rauchglasboden</p> <p> Nicht in Graphit-Dekor lieferbar!</p> <p>Höhe Kopfteil: 94 cm Höhe Fußteil: 48 cm Höhe Oberkante Bettseite: 48 cm</p> | 140 x 190 140 x 200 140 x 210 140 x 220 160 x 190 160 x 200 160 x 210 160 x 220 180 x 190 180 x 200 180 x 210 180 x 220 | 209 x 199 209 x 209 209 x 219 209 x 229 229 x 199 229 x 209 229 x 219 229 x 229 249 x 199 249 x 209 249 x 219 249 x 229 | 660 661 662 663 664 665 666 667 668 669 670 671 | |
|  <p>Überstehendes Paneel im Korpus-Farbtone mit Lamellen in Bianco-Eiche-NB ohne Rauchglasboden</p> <p>Höhe Kopfteil: 94 cm Höhe Fußteil: 48 cm Höhe Oberkante Bettseite: 48 cm</p> | 140 x 190 140 x 200 140 x 210 140 x 220 160 x 190 160 x 200 160 x 210 160 x 220 180 x 190 180 x 200 180 x 210 180 x 220 | 209 x 199 209 x 209 209 x 219 209 x 229 229 x 199 229 x 209 229 x 219 229 x 229 249 x 199 249 x 209 249 x 219 249 x 229 | 672 673 674 675 680 681 682 683 684 685 686 687 | |
|  <p>Überstehendes Paneel in Bianco-Eiche-NB mit Lamellen in Bianco-Eiche-NB ohne Rauchglasboden</p> <p>Höhe Kopfteil: 94 cm Höhe Fußteil: 48 cm Höhe Oberkante Bettseite: 48 cm</p> | 140 x 190 140 x 200 140 x 210 140 x 220 160 x 190 160 x 200 160 x 210 160 x 220 180 x 190 180 x 200 180 x 210 180 x 220 | 209 x 199 209 x 209 209 x 219 209 x 229 229 x 199 229 x 209 229 x 219 229 x 229 249 x 199 249 x 209 249 x 219 249 x 229 | 690 691 692 693 694 695 696 697 698 699 246 247 | |
| | | | | |





Nevada

gültig ab 06.12.2023

Betten

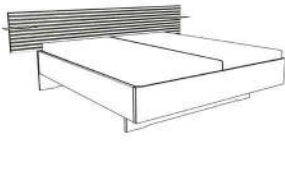
Bettseiten-Höhe 48 cm

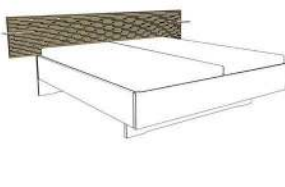





Liegehöhen-Verstellung 4-fach

| Beschreibung | Liegefläche in cm | Stellfläche in cm | Art.-Nr. | EURO |
|--|--|--|--|------|
|  <p>Überstehendes Paneel im Korpus-Farbton mit Lamellen im Korpus-Farbton mit Rauchglasboden</p> <p>Höhe Kopfteil: 94 cm Höhe Fußteil: 48 cm Höhe Oberkante Bettseite: 48 cm</p>  Nicht in Graphit-Dekor lieferbar! | 140 x 190 140 x 200 140 x 210 140 x 220 160 x 190 160 x 200 160 x 210 160 x 220 180 x 190 180 x 200 180 x 210 180 x 220 | 209 x 199 209 x 209 209 x 219 209 x 229 229 x 199 229 x 209 229 x 219 229 x 229 249 x 199 249 x 209 249 x 219 249 x 229 | 800 801 802 803 804 805 806 807 808 809 810 811 | |
|  <p>Überstehendes Paneel im Korpus-Farbton mit Lamellen in Bianco-Eiche-NB mit Rauchglasboden</p> <p>Höhe Kopfteil: 94 cm Höhe Fußteil: 48 cm Höhe Oberkante Bettseite: 48 cm</p> | 140 x 190 140 x 200 140 x 210 140 x 220 160 x 190 160 x 200 160 x 210 160 x 220 180 x 190 180 x 200 180 x 210 180 x 220 | 209 x 199 209 x 209 209 x 219 209 x 229 229 x 199 229 x 209 229 x 219 229 x 229 249 x 199 249 x 209 249 x 219 249 x 229 | 820 821 822 823 824 825 826 827 828 829 830 831 | |
|  <p>Überstehendes Paneel in Bianco-Eiche-NB mit Lamellen in Bianco-Eiche-NB mit Rauchglasboden</p> <p>Höhe Kopfteil: 94 cm Höhe Fußteil: 48 cm Höhe Oberkante Bettseite: 48 cm</p> | 140 x 190 140 x 200 140 x 210 140 x 220 160 x 190 160 x 200 160 x 210 160 x 220 180 x 190 180 x 200 180 x 210 180 x 220 | 209 x 199 209 x 209 209 x 219 209 x 229 229 x 199 229 x 209 229 x 219 229 x 229 249 x 199 249 x 209 249 x 219 249 x 229 | 836 837 838 839 840 841 842 843 844 845 846 847 | |
| | | | | |





Betten

Bettseiten-Höhe 48 cm

Liegehöhen-Verstellung 4-fach

| Beschreibung | Liegefläche in cm | Stellfläche in cm | Art.-Nr. | EURO |
|---|----------------------|----------------------|------------|------|
|  <p>Überstehendes Paneel im Korpus-Farbtone mit Lamellen im Korpus-Farbtone mit Rauchglasboden und LED-Beleuchtung</p>  <p>Höhe Kopfteil: 94 cm Höhe Fußteil: 48 cm Höhe Oberkante Bettseite: 48 cm</p> <p>Dieses Produkt enthält Lichtquellen der Energieeffizienzklasse G</p>  <p>Nicht in Graphit-Dekor lieferbar!</p> | 140 x 190 | 209 x 199 | P01 | |
| | 140 x 200 | 209 x 209 | P02 | |
| | 140 x 210 | 209 x 219 | P03 | |
| | 140 x 220 | 209 x 229 | P04 | |
| | 160 x 190 | 229 x 199 | P05 | |
| | 160 x 200 | 229 x 209 | P06 | |
| | 160 x 210 | 229 x 219 | P07 | |
| | 160 x 220 | 229 x 229 | P08 | |
| | 180 x 190 | 249 x 199 | P09 | |
| | 180 x 200 | 249 x 209 | P10 | |
| | 180 x 210 | 249 x 219 | P11 | |
| | 180 x 220 | 249 x 229 | P12 | |
|  <p>Überstehendes Paneel im Korpus-Farbtone mit Lamellen in Bianco-Eiche-NB mit Rauchglasboden und LED-Beleuchtung</p>  <p>Höhe Kopfteil: 94 cm Höhe Fußteil: 48 cm Höhe Oberkante Bettseite: 48 cm</p> <p>Dieses Produkt enthält Lichtquellen der Energieeffizienzklasse G</p> | 140 x 190 | 209 x 199 | P13 | |
| | 140 x 200 | 209 x 209 | P14 | |
| | 140 x 210 | 209 x 219 | P15 | |
| | 140 x 220 | 209 x 229 | P16 | |
| | 160 x 190 | 229 x 199 | P17 | |
| | 160 x 200 | 229 x 209 | P18 | |
| | 160 x 210 | 229 x 219 | P19 | |
| | 160 x 220 | 229 x 229 | P20 | |
| | 180 x 190 | 249 x 199 | P21 | |
| | 180 x 200 | 249 x 209 | P22 | |
| | 180 x 210 | 249 x 219 | P23 | |
| | 180 x 220 | 249 x 229 | P24 | |
|  <p>Überstehendes Paneel in Bianco-Eiche-NB mit Lamellen in Bianco-Eiche-NB mit Rauchglasboden und LED-Beleuchtung</p>  <p>Höhe Kopfteil: 94 cm Höhe Fußteil: 48 cm Höhe Oberkante Bettseite: 48 cm</p> <p>Dieses Produkt enthält Lichtquellen der Energieeffizienzklasse G</p> | 140 x 190 | 209 x 199 | P25 | |
| | 140 x 200 | 209 x 209 | P26 | |
| | 140 x 210 | 209 x 219 | P27 | |
| | 140 x 220 | 209 x 229 | P28 | |
| | 160 x 190 | 229 x 199 | P29 | |
| | 160 x 200 | 229 x 209 | P30 | |
| | 160 x 210 | 229 x 219 | P31 | |
| | 160 x 220 | 229 x 229 | P32 | |
| | 180 x 190 | 249 x 199 | P33 | |
| | 180 x 200 | 249 x 209 | P34 | |
| | 180 x 210 | 249 x 219 | P35 | |
| | 180 x 220 | 249 x 229 | P36 | |

Zusatzelemente für Betten

| Beschreibung | Maße in cm | | | Art.-Nr. | EURO |
|--|-------------------|-------------|-------------|--|------|
| | B | H | T | | |
|  <p>1 Paar Winkelpolster für Kopfteil, in Kunstleder anthrazit</p> <p>- für Bettbreite 140 und 160 cm - für Bettbreite 180 cm</p> | 2 x 62 2 x 82 | 19 19 | 5,5 5,5 | M01 M02 | |
|  <p>LED-Flexleuchte mit Power-LED in Schiefer</p> <p>Paar</p> <p><small>Dieses Produkt enthält eine Licht- quelle der Energieeffizienzklasse G</small></p> | 50 | 2 | 4 | 100 | |
|  <p>LED-Ambiente-Beleuchtung zur Befestigung hinter dem Kopfteil</p> <p>- für Bettbreite 140 cm - für Bettbreite 160 cm - für Bettbreite 180 cm</p> <p><small>Dieses Produkt enthält eine Licht- quelle der Energieeffizienzklasse F</small></p> | 207 227 247 | 1 1 1 | 1 1 1 | 101 248 249 | |
|  <p>LED-Fußteilbeleuchtung</p> <p>- für Bettbreite 140 / 160 / 180 cm</p> <p><small>Dieses Produkt enthält eine Licht- quelle der Energieeffizienzklasse E</small></p> | 60 | 2,4 | 3,5 | 755 | |



Zusatzelemente für Betten

| Beschreibung | Maße in cm | | | Art.-Nr. | EURO |
|--|------------------|----------|------------|--------------------------|------|
| | B | H | T | | |
|  <p>Unterbau-Bettkasten für Lattenroste mit Springauf-Beschlag für Bettlänge 200 cm</p> <ul style="list-style-type: none"> - für Liegefläche 160 x 200 cm - für Liegefläche 180 x 200 cm | 140 160 | 21 21 | 167 167 | 250 251 | |
|  <p>Lattenroste mit Springauf-Beschlag für Bettlänge 200cm, 2er Set</p> <ul style="list-style-type: none"> - für Liegefläche 160 x 200 cm - für Liegefläche 180 x 200 cm | 2 x 80 2 x 90 | 9 9 | 200 200 | 252 253 | |
|    | | | | | |
|   <p>Hier finden Sie weitere Informationen</p> | | | | | |
|  <p>Continental-Adapter-Set zur Erhöhung der Einlegetiefe:</p> <ul style="list-style-type: none"> - um 4,8 cm bei Bettseitenhöhe 48 cm | 1 | 1 | 1 | 097 | |

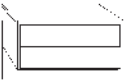

Beimöbel, H 48 cm

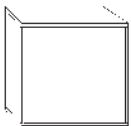
| Beschreibung | Maße in cm | | | Art.-Nr. | EURO | |
|---|---|----|----|------------|------------|--|
| | B | H | T | | | |
|  <p>Nachtschrank, 1 Auszug schwebend</p> <p>- Front im Korpus-Farbton Stück Paar</p> <p>- Front in Bianco-Eiche-Nachbildung Stück Paar</p> <p>- Front in Champagner-Dekor Stück Paar</p> <p>- Front in Graphit-Dekor Stück Paar</p> <p>- Front in Glas Champagner Stück Paar</p> | 60 | 48 | 43 | A30 | | |
| | 60 | 48 | 43 | A31 | | |
| | 60 | 48 | 43 | A32 | | |
| | 60 | 48 | 43 | A33 | | |
| | 60 | 48 | 43 | A34 | | |
| | 60 | 48 | 43 | A35 | | |
| | 60 | 48 | 43 | A36 | | |
| | 60 | 48 | 43 | A37 | | |
| | 60 | 48 | 43 | A38 | | |
| | 60 | 48 | 43 | A39 | | |
| |  <p>Nachtschrank, 2 Auszüge schwebend</p> <p>- Front im Korpus-Farbton Stück Paar</p> <p>- Front in Bianco-Eiche-Nachbildung Stück Paar</p> <p>- Front in Champagner-Dekor Stück Paar</p> <p>- Front in Graphit-Dekor Stück Paar</p> <p>- Front Glas Champagner Stück Paar</p> | 60 | 48 | 43 | A85 | |
| | | 60 | 48 | 43 | A86 | |
| 60 | | 48 | 43 | A87 | | |
| 60 | | 48 | 43 | A88 | | |
| 60 | | 48 | 43 | A89 | | |
| 60 | | 48 | 43 | A90 | | |
| 60 | | 48 | 43 | A91 | | |
| 60 | | 48 | 43 | A92 | | |
| 60 | | 48 | 43 | A93 | | |
| 60 | | 48 | 43 | A94 | | |

Beimöbel, H 48 cm Gleitfüße in schwarz



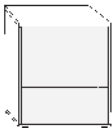









| Beschreibung | Maße in cm | | | Art.-Nr. | EURO | | | |
|--|-------------------------------------|-------|-------|----------|------------|------------|------------|--|
| | B | H | T | | | | | |
|   Breite 40 cm Höhe 48 cm | Nachtschrank, 2,5 Auszüge | | | | | | | |
| | - Front im Korpus-Farbton | Stück | 40 | 48 | 43 | A01 | | |
| | | Paar | 40 | 48 | 43 | A02 | | |
| | - Front in Bianco-Eiche-Nachbildung | Stück | 40 | 48 | 43 | A03 | | |
| | | Paar | 40 | 48 | 43 | A04 | | |
| | - Front in Champagner-Dekor | Stück | 40 | 48 | 43 | A05 | | |
| | | Paar | 40 | 48 | 43 | A06 | | |
| | - Front in Graphit-Dekor | Stück | 40 | 48 | 43 | A07 | | |
| | | Paar | 40 | 48 | 43 | A08 | | |
| | - Front in Glas Champagner | Stück | 40 | 48 | 43 | A09 | | |
| | Paar | 40 | 48 | 43 | A10 | | | |
|  Breite 60 cm Höhe 48 cm | - Front im Korpus-Farbton | | Stück | 60 | 48 | 43 | A15 | |
| | | | Paar | 60 | 48 | 43 | A16 | |
| | - Front in Bianco-Eiche-Nachbildung | Stück | 60 | 48 | 43 | A17 | | |
| | | Paar | 60 | 48 | 43 | A18 | | |
| | - Front in Champagner-Dekor | Stück | 60 | 48 | 43 | A19 | | |
| | | Paar | 60 | 48 | 43 | A20 | | |
| | - Front in Graphit-Dekor | Stück | 60 | 48 | 43 | A21 | | |
| | | Paar | 60 | 48 | 43 | A22 | | |
| | - Front in Glas Champagner | Stück | 60 | 48 | 43 | A23 | | |
| | | Paar | 60 | 48 | 43 | A24 | | |

Beimöbel, H 63 cm Gleitfüße in schwarz





| Beschreibung | Maße in cm | | | Art.-Nr. | EURO | | |
|---|-------------------------------------|-------|----|----------|------------|------------|--|
| | B | H | T | | | | |
|   Breite 40 cm Höhe 63 cm | Nachtschrank, 2,5 Auszüge | | | | | | |
| | - Front im Korpus-Farbton | Stück | 40 | 63 | 43 | A60 | |
| | | Paar | 40 | 63 | 43 | A61 | |
| | - Front in Bianco-Eiche-Nachbildung | Stück | 40 | 63 | 43 | A62 | |
| | | Paar | 40 | 63 | 43 | A63 | |
| | - Front in Champagner-Dekor | Stück | 40 | 63 | 43 | A64 | |
| | | Paar | 40 | 63 | 43 | A65 | |
| | - Front in Graphit-Dekor | Stück | 40 | 63 | 43 | A66 | |
| | | Paar | 40 | 63 | 43 | A67 | |
| | | Stück | 40 | 63 | 43 | A68 | |
| | Paar | 40 | 63 | 43 | A69 | | |
|  Breite 60 cm Höhe 63 cm | - | | | | | | |
| | - Front im Korpus-Farbton | Stück | 60 | 63 | 43 | A75 | |
| | | Paar | 60 | 63 | 43 | A76 | |
| | - Front in Bianco-Eiche-Nachbildung | Stück | 60 | 63 | 43 | A77 | |
| | | Paar | 60 | 63 | 43 | A78 | |
| | - Front in Champagner-Dekor | Stück | 60 | 63 | 43 | A79 | |
| | | Paar | 60 | 63 | 43 | A80 | |
| | - Front in Graphit-Dekor | Stück | 60 | 63 | 43 | A81 | |
| | | Paar | 60 | 63 | 43 | A82 | |
| | - Front in Glas Champagner | Stück | 60 | 63 | 43 | A83 | |
| | Paar | 60 | 63 | 43 | A84 | | |

Beimöbel Gleitfüße in schwarz

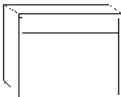

Alle Drehtüren inkl. gedämpfter Scharniere

| | Beschreibung | Maße in cm | | | Art.-Nr. | EURO |
|--|--|--|--|----|------------|------|
| | | B | H | T | | |
| | Kommode , 2-türig, mit einem durchgehenden Einlegeboden | | | | | |
| | - Front im Korpus-Farbton | 80 | 86 | 43 | B80 | |
| | - Front in Bianco-Eiche-Nachbildung | 80 | 86 | 43 | B81 | |
| | - Front in Champagner-Dekor | 80 | 86 | 43 | B82 | |
| | - Front in Graphit-Dekor | 80 | 86 | 43 | B83 | |
| | - Front in Glas Champagner | 80 | 86 | 43 | B84 | |
| | - Front im Korpus-Farbton mit Lamellen im Korpus-Farbton | 80 | 86 | 43 | B01 | |
| |  Modell-Nr. 234 |  Modell-Nr. 235 |  Modell-Nr. 252 | | | |
| | - Front im Korpus-Farbton mit Lamellen in Bianco-Eiche-Nachbildung | 80 | 86 | 43 | B02 | |
| |  Modell-Nr. 234 |  Modell-Nr. 235 |  Modell-Nr. 252 | | | |
| | - Front in Bianco-Eiche-Nachbildung mit Lamellen im Korpus-Farbton | 80 | 86 | 43 | B03 | |
|  Modell-Nr. 234 |  Modell-Nr. 235 |  Modell-Nr. 252 | | | | |
| | - Front in Bianco-Eiche-Nachbildung mit Lamellen in Bianco-Eiche-Nachbildung | 80 | 86 | 43 | B04 | |
| |  Modell-Nr. 234 |  Modell-Nr. 235 |  Modell-Nr. 252 | | | |

Beimöbel Gleitfüße in schwarz

| | Beschreibung | Maße in cm | | | Art.-Nr. | EURO |
|--|---|------------|----|----|------------|------|
| | | B | H | T | | |
|   Breite 40 cm | Schubkastenkommode, 5 Auszüge | | | | | |
| | - Front im Korpus-Farbtön | 40 | 86 | 43 | B85 | |
| | - Front im Korpus-Farbtön, oberer Auszug in Bianco-Eiche-Nachbildung | 40 | 86 | 43 | B86 | |
| | - Front in Bianco-Eiche-Nachbildung | 40 | 86 | 43 | B87 | |
| | - Front in Champagner-Dekor | 40 | 86 | 43 | B88 | |
| | - Front in Champagner-Dekor, oberer Auszug in Bianco-Eiche-Nachbildung | 40 | 86 | 43 | B89 | |
| | - Front in Graphit-Dekor | 40 | 86 | 43 | B90 | |
| | - Front in Graphit-Dekor, oberer Auszug in Bianco-Eiche-Nachbildung | 40 | 86 | 43 | B91 | |
| | - Front in Glas Champagner | 40 | 86 | 43 | B92 | |
| | - Front in Glas Champagner, oberer Auszug in Bianco-Eiche-Nachbildung | 40 | 86 | 43 | B93 | |
|   Breite 60 cm | Schubkastenkommode, 5 Auszüge | | | | | |
| | - Front im Korpus-Farbtön | 60 | 86 | 43 | B94 | |
| | - Front im Korpus-Farbtön, oberer Auszug in Bianco-Eiche-Nachbildung | 60 | 86 | 43 | B95 | |
| | - Front in Bianco-Eiche-Nachbildung | 60 | 86 | 43 | B96 | |
| | - Front in Champagner-Dekor | 60 | 86 | 43 | B97 | |
| | - Front in Champagner-Dekor, oberer Auszug in Bianco-Eiche-Nachbildung | 60 | 86 | 43 | B98 | |
| | - Front in Graphit-Dekor | 60 | 86 | 43 | B99 | |
| | - Front in Graphit-Dekor, oberer Auszug in Bianco-Eiche-Nachbildung | 60 | 86 | 43 | F01 | |
| | - Front in Glas Champagner | 60 | 86 | 43 | F02 | |
| | - Front in Glas Champagner, oberer Auszug in Bianco-Eiche-Nachbildung | 60 | 86 | 43 | F03 | |

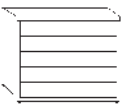
Beimöbel Gleitfüße in schwarz

| Beschreibung | Maße in cm | | | Art.-Nr. | EURO | |
|--|--|-----|----|------------|------------|--|
| | B | H | T | | | |
|  Schubkastenkommode, 5 Auszüge  Breite 80 cm | - Front im Korpus-Farbtön | 80 | 86 | 43 | F04 | |
| | - Front im Korpus-Farbtön, oberer Auszug in Bianco-Eiche-Nachbildung | 80 | 86 | 43 | F05 | |
| | - Front in Bianco-Eiche-Nachbildung | 80 | 86 | 43 | F06 | |
| | - Front in Champagner-Dekor | 80 | 86 | 43 | F07 | |
| | - Front in Champagner-Dekor, oberer Auszug in Bianco-Eiche-Nachbildung | 80 | 86 | 43 | F08 | |
| | - Front in Graphit-Dekor | 80 | 86 | 43 | F09 | |
| | - Front in Graphit-Dekor, oberer Auszug in Bianco-Eiche-Nachbildung | 80 | 86 | 43 | F10 | |
| | - Front in Glas Champagner | 80 | 86 | 43 | F11 | |
| | - Front in Glas Champagner, oberer Auszug in Bianco-Eiche-Nachbildung | 80 | 86 | 43 | F12 | |
| | - Front im Korpus-Farbtön | 141 | 86 | 43 | F13 | |
| | - Front im Korpus-Farbtön, oberer Auszug in Bianco-Eiche-Nachbildung | 141 | 86 | 43 | F14 | |
| | - Front in Bianco-Eiche-Nachbildung | 141 | 86 | 43 | F15 | |
| - Front in Champagner-Dekor | 141 | 86 | 43 | F16 | | |
| - Front in Champagner-Dekor, oberer Auszug in Bianco-Eiche-Nachbildung | 141 | 86 | 43 | F17 | | |
| - Front in Graphit-Dekor | 141 | 86 | 43 | F18 | | |
| - Front in Graphit-Dekor, oberer Auszug in Bianco-Eiche-Nachbildung | 141 | 86 | 43 | F19 | | |
| - Front in Glas Champagner | 141 | 86 | 43 | F20 | | |
| - Front in Glas Champagner, oberer Auszug in Bianco-Eiche-Nachbildung | 141 | 86 | 43 | F21 | | |

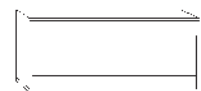

Breite 141 cm

Beimöbel
Gleitfüße in schwarz

Alle Drehtüren inkl. gedämpfter Scharniere

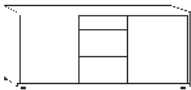
| Beschreibung | Maße in cm | | | Art.-Nr. | EURO |
|---|------------|----|----|------------|------|
| | B | H | T | | |
|  <p>Kombikommode, 5 Auszüge mittig, 2 Türen außen, je Türenfach 1 Einlegeboden</p> <p>- Front im Korpus-Farbton</p> <p>- Front im Korpus-Farbton, Auszüge in Bianco-Eiche-Nachbildung</p> <p>- Front in Bianco-Eiche-Nachbildung</p> <p>- Front in Champagner-Dekor</p> <p>- Front in Champagner-Dekor, Auszüge in Bianco-Eiche-Nachbildung</p> <p>- Front in Graphit-Dekor</p> <p>- Front in Graphit-Dekor, Auszüge in Bianco-Eiche-Nachbildung</p> <p>- Front in Glas Champagner</p> <p>- Front in Glas Champagner, Auszüge in Bianco-Eiche-Nachbildung</p> | 141 | 86 | 43 | F22 | |
| | 141 | 86 | 43 | F23 | |
| | 141 | 86 | 43 | F24 | |
| | 141 | 86 | 43 | F25 | |
| | 141 | 86 | 43 | F26 | |
| | 141 | 86 | 43 | F27 | |
| | 141 | 86 | 43 | F28 | |
| | 141 | 86 | 43 | F29 | |
| | 141 | 86 | 43 | F30 | |
| | | | | | |

Beimöbel Gleitfüße in schwarz

Alle Drehtüren inkl. gedämpfter Scharniere

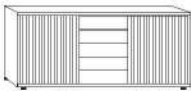
| Beschreibung | Maße in cm | | | Lamellen im Korpus-Farbton | | Lamellen in Bianco-Eiche-NB | |
|---|------------|----|----|-------------------------------|------|--------------------------------|------|
| | B | H | T | Art.-Nr. | EURO | Art.-Nr. | EURO |
|  <p>Kombikommode, 5 Auszüge mittig, 2 Türen außen, je Türenfach 1 Einlegeboden</p> <p>Türen mit Lamellen</p> <ul style="list-style-type: none"> - Front im Korpus-Farbton - Türen im Korpus-Farbton, Auszüge in Bianco-Eiche-Nachbildung - Türen im Korpus-Farbton, Auszüge in Champagner-Dekor - Türen im Korpus-Farbton, Auszüge in Graphit-Dekor - Türen im Korpus-Farbton, Auszüge in Glas Champagner - Türen in Bianco-Eiche-Nachbildung, Auszüge in Champagner-Dekor - Türen in Bianco-Eiche-Nachbildung, Auszüge in Graphit-Dekor - Türen in Bianco-Eiche-Nachbildung, Auszüge in Glas Champagner | | | | | | | |
| | 141 | 86 | 43 | B05 | | B13 | |
| | 141 | 86 | 43 | B06 | | B14 | |
| | 141 | 86 | 43 | B07 | | B15 | |
| | 141 | 86 | 43 | B08 | | B16 | |
| | 141 | 86 | 43 | B09 | | B17 | |
| | 141 | 86 | 43 | B10 | | B18 | |
| | 141 | 86 | 43 | B11 | | B19 | |
| | 141 | 86 | 43 | B12 | | B20 | |

Lamellen im Korpus-Farbton



Modell-Nr.
234



Modell-Nr.
235



Modell-Nr.
252

Lamellen in Bianco-Eiche-Nachbildung



Modell-Nr.
234



Modell-Nr.
235



Modell-Nr.
252

Beimöbel
Gleitfüße in schwarz

Alle Drehtüren inkl. gedämpfter Scharniere

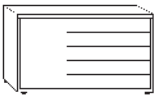
| Beschreibung | Maße in cm | | | Art.-Nr. | EURO |
|--|------------|----|----|------------|------|
| | B | H | T | | |
|  <p>Kombikommode, 5 Auszüge rechts, 1 Tür links, dahinter einen Einlegeboden</p> <ul style="list-style-type: none"> - Front im Korpus-Farbtön - Front im Korpus-Farbtön, Auszüge in Bianco-Eiche-Nachbildung - Front in Bianco-Eiche-Nachbildung - Front in Champagner-Dekor - Front in Champagner-Dekor, Auszüge in Bianco-Eiche-Nachbildung - Front in Graphit-Dekor - Front in Graphit-Dekor, Auszüge in Bianco-Eiche-Nachbildung - Front in Glas Champagner - Front in Glas Champagner, Auszüge in Bianco-Eiche-Nachbildung | 120 | 86 | 43 | F31 | |
| | 120 | 86 | 43 | F32 | |
| | 120 | 86 | 43 | F33 | |
| | 120 | 86 | 43 | F34 | |
| | 120 | 86 | 43 | F35 | |
| | 120 | 86 | 43 | F36 | |
| | 120 | 86 | 43 | F37 | |
| | 120 | 86 | 43 | F38 | |
| | 120 | 86 | 43 | F39 | |
| | | | | | |

Nevada

gültig ab 06.12.2023

Beimöbel Gleitfüße in schwarz

Alle Drehtüren inkl. gedämpfter Scharniere

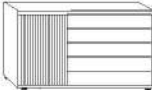
| Beschreibung | Maße in cm | | | Lamellen im Korpus-Farbton | | Lamellen in Bianco-Eiche-NB | |
|---|------------|----|----|-------------------------------|------|--------------------------------|------|
| | B | H | T | Art.-Nr. | EURO | Art.-Nr. | EURO |
|  <p>Kombikommode, 5 Auszüge rechts, 1 Tür links, dahinter ein Einlegeboden</p> <p>Tür mit Lamellen</p> <ul style="list-style-type: none"> - Front im Korpus-Farbton - Tür im Korpus-Farbton, Auszüge in Bianco-Eiche-Nachbildung - Tür im Korpus-Farbton, Auszüge in Champagner-Dekor - Tür im Korpus-Farbton, Auszüge in Graphit-Dekor - Tür im Korpus-Farbton, Auszüge in Glas Champagner - Tür in Bianco-Eiche-Nachbildung, Auszüge in Champagner-Dekor - Tür in Bianco-Eiche-Nachbildung, Auszüge in Graphit-Dekor - Tür in Bianco-Eiche-Nachbildung, Auszüge in Glas Champagner | | | | | | | |
| | 120 | 86 | 43 | B21 | | B29 | |
| | 120 | 86 | 43 | B22 | | B30 | |
| | 120 | 86 | 43 | B23 | | B31 | |
| | 120 | 86 | 43 | B24 | | B32 | |
| | 120 | 86 | 43 | B25 | | B33 | |
| | 120 | 86 | 43 | B26 | | B34 | |
| | 120 | 86 | 43 | B27 | | B35 | |
| | 120 | 86 | 43 | B28 | | B36 | |

Lamellen im Korpus-Farbton



Modell-Nr.
234



Modell-Nr.
235



Modell-Nr.
252

Lamellen in Bianco-Eiche-Nachbildung



Modell-Nr.
234







Modell-Nr.
235

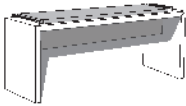

Modell-Nr.
252

Beimöbel

| Beschreibung | Maße in cm | | | Art.-Nr. | EURO |
|---|------------|----|----|------------|------|
| | B | H | T | | |
|  <p>Ankleidebank mit Polster in Kunstleder</p> <ul style="list-style-type: none"> - mit Kunstleder Champagner - mit Kunstleder anthrazit | 120 | 53 | 40 | F40 | |
| | 120 | 53 | 40 | F41 | |
|  <p>Ankleidebank auf Kufen und einem Auszug mit Polster in Kunstleder Champagner</p> <ul style="list-style-type: none"> - Front im Korpus-Farbton - Front in Bianco-Eiche-Nachbildung - Front in Champagner-Dekor - Front in Graphit-Dekor - Front in Glas Champagner | 141 | 50 | 43 | 090 | |
| | 141 | 50 | 43 | 091 | |
| | 141 | 50 | 43 | 092 | |
| | 141 | 50 | 43 | 094 | |
| | 141 | 50 | 43 | 095 | |
|  <p>Hängespiegel, Aufhängung quer oder senkrecht</p> | 110 | 85 | 3 | 086 | |
|  <p>Wandspiegel</p> | 60 | 80 | 3 | 087 | |
| | | | | | |