

Focus



01.08.2022 - bis auf Widerruf



Schwebetürenschränke

Türen: Dekor und bedruckte Spiegelauflege

Passepartout: ohne oder mit Beleuchtung

Breiten: 251, 301 cm

Höhe: 223 cm

Griffleisten und Aufleistungen: alufarben



Ganz einfach planbar mit:

furnplan

Beimöbel und passende Extras

MONTIERT Zubehör 1.0 finden Sie nach den Schränken..

Front/Korpus:



alpinweiß



seidengrau



graphit

Spiegel mit Absetzung in:



Farbglas seiden-grau



Farbglas basalt

Qualitätsmerkmale

MONTIERT



Innenfarbe
Dekor-Druck
Textilne

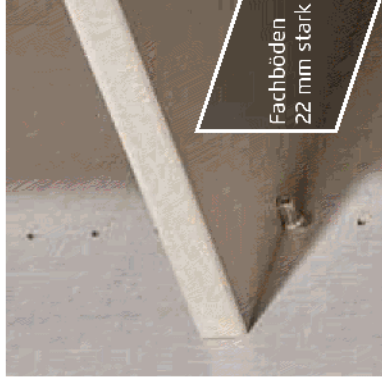

Fachböden
22 mm stark



**EASY
SLIDE**

Führungsschle-
nen aus Metall,
Schwebetüren-
dämpfer optional

Ausnahme: Modell Lias/Yubari mit Dämpfung



Drehtüren mit
Dickkante



Drehtüren inkl.
soft-close



Extras für
Schränke siehe
ORANGE
- MONTIERT
Zubehör 1,0/11.



Schubkästen mit
Unterfahrschiene,
Selbsteinzug +
Dämpfung

zeitlose
Optik

attraktive
Frontgestal-
tungen

langlebige
Produkt-
qualität

ausgezeich-
nete Möbel-
beschläge

umfangreich-
es Zubehör

Qualität und Material



10 Jahre Herstellergarantie:
Die Garantiebedingungen finden Sie auf
und in Hinweisen,
die dem Produkt beiliegen.



Dekor-Druck
Die Möbelteile mit Dekor-Druck haben eine gleichmäßig
schöne, strapazierfähige Oberfläche.



Belastbarkeit
Die Belastungsgrenzen für alle Möbel- und Zubehörteile finden Sie in
der „Belastungstabeller“ unter:



WOODMAX Spanplatten

Die wohngesunde Frischholz-Spanplatte, speziell
für die Verwendung in Wohnräumen, mit dem
Prädikat „Schadstoffarm“. Für unsere Woodmax-
Spanplatte verwenden wir nur unbelastete
Schwach- und Bruchhölzer aus nachhaltigem
Forstbetrieb regionaler Wälder.

Unser Rohstoff aus der Natur

Für seinen Plattenwerkstoff erhielt ver-
schiedene Auszeichnungen. Strenge Prüfungen
von neutralen Instituten bestätigen kontinuierlich
die Unbedenklichkeit von Material und Verfahren.



Ausgezeichnet und zertifiziert



made in GERMANY
Nachhaltig gefertigt

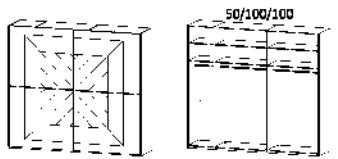
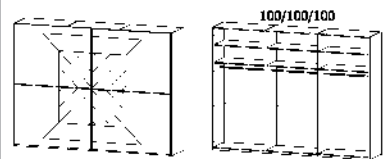

MOD.-NR.	FRONTAUSFÜHRUNG	SPIEGEL MIT ABSETZUNGEN			
Front-/Korpusfarbe ▼		Absetzungen Farbglas basalt	Absetzungen Farbglas seidengrau	Front alpinweiß, Absetzungen Farbglas basalt	Front alpinweiß, Absetzungen Farbglas seidengrau
alpinweiß	A001F	A002F	-	-	-
seidengrau	-	-	A007F	A008F	
graphit	A003F	A004F	A005F	A006F	

Griffleisten und Leisten ► ALUFARBEN

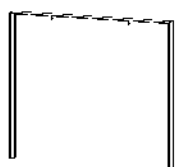
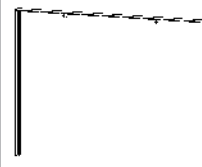
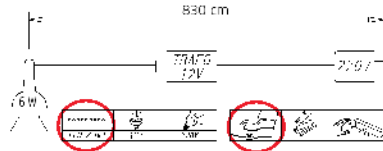
SCHWEBETÜREN- SCHRÄNKE	Breite in cm	251	301	Türendämpfer	
		Tiefe 68 cm			Bitte unter Mod.-Nr. A0066 bestellen.
EASY SLIDE	Skizze				
	Türenanzahl	2	2	Schwebetürendämpfer 2er Set EASY SLIDE	
HÖHE 223 CM	▼ Art.-Nr.	▼ Preis	...	HÖHE 223 CM	
	52A8		52A9		9DM1

PASSEPARTOUTS IN KORPUSFARBE	Breite in cm	259	309	830 cm	
		Gesamttiefe incl. Schrank: 69 cm			
Bitte unter der gleichen Modell-Nr. wie die Schränke bestellen!	Skizze			Dieses Produkt enthält eine Lichtquelle der Energieeffizienzklasse E.	
	HÖHE 226 CM	▼ Art.-Nr.	▼ Preis	...	HÖHE 226 CM
ohne Beleuchtung	9P69		9P73		EPREL 766798
mit waagrechter LED-Beleuchtung 	9P67		9P71		

AUSZUG AUS ALDONO-DELUXE

MONTIERT

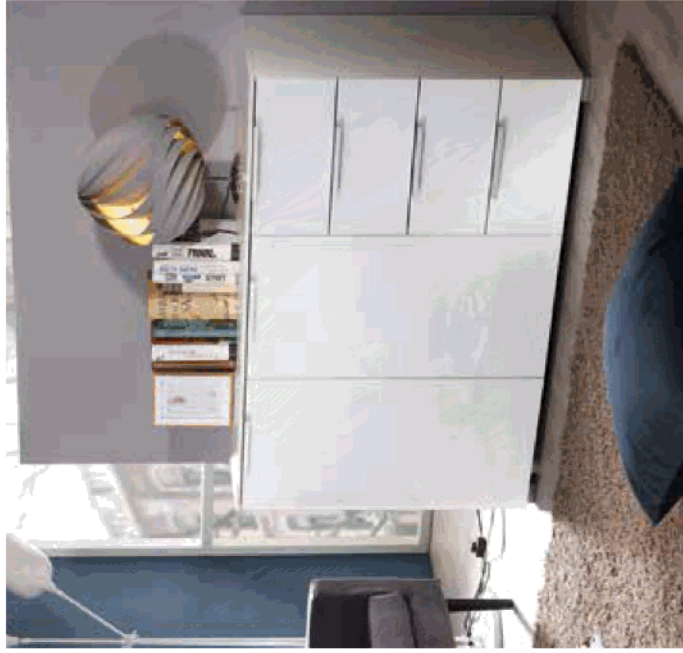

ALDONO-DELUXE

Beimöbel: Dekor oder Farbglas

3 Griffvarianten: alufarben

FüÙe: alufarben

Schubkästen: mit Unterflurschiene, Selbstzug und Dämpfung



Front und Korpusfarben:

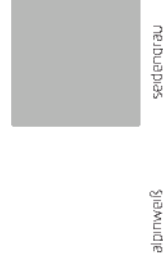

Frontfarben:

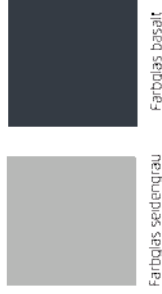

Griffvarianten:

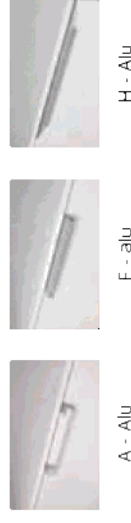















AUSZUG AUS ALDONO-DELUXE

MONTIERT

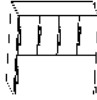
1	MOD.-NR.	FRONTAUSFÜHRUNG ▶	DEKOR	FARBGLAS
	Korpusfarbe ▼	Front in korpusfarben		seidengrau
	alpinweiß	A010_		A012_
	seidengrau	A028_		A030_
	graphit	A034_		A036_

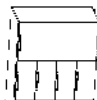
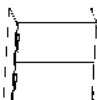
2	GRIFFVARIANTE ▶	A · ALU	F · ALU	H · ALU
---	-----------------	---------	---------	---------

3	Breite in cm	40	50	40	50	40
	Skizze					
	Bezeichnung	Nachttisch	Nachttisch	Nachttisch	Nachttisch	Kommode
	Bezeichnung	2 Schubkästen	2 Schubkästen	3 Schubkästen	3 Schubkästen	4 Schubkästen
	Maße (B/H/T)	↔40 cm ↑49 cm ↙42 cm	↔50 cm ↑49 cm ↙42 cm	↔40 cm ↑61 cm ↙42 cm	↔50 cm ↑61 cm ↙42 cm	↔40 cm ↑81 cm ↙42 cm
		▼ Art.-Nr.	▼ Preis			
	Front Dekor	6D15	6D16	6D17	6D18	6D25
	Front Farbglas	6G15	6G16	6G17	6G18	6G25

Breite in cm	80	80	120	160	40
Skizze					
Bezeichnung	Kommode	Kommode	Kommode	Kommode	Kommode
Bezeichnung	1-türig, Anschlag links, 4 Schubkästen	4 Schubkästen	2-türig, 4 Schubkästen	2-türig, 4 Schubkästen	6 Schubkästen
Maße (B/H/T)	↔80 cm ↑81 cm ↙42 cm	↔80 cm ↑81 cm ↙42 cm	↔120 cm ↑81 cm ↙42 cm	↔160 cm ↑81 cm ↙42 cm	↔40 cm ↑119 cm ↙42 cm
	▼ Art.-Nr.	▼ Preis			
	Front Dekor	6D72	6D26	6D75	6D76
	Front Farbglas	6G72	6G26	6G75	6G76
					7D32
					7G32

Info: Weitere Beimöbel, andere Farben sowie Griffarten finden Sie in der gesamten Modell-Preisliste von Aldono/Aldono-Deluxe.

ZUBEHÖR 1.0

MONTIERT

für Dreh-/Schwebetürenschränke
Elementbreite 50, 75, 100 cm



Farbe	Modell-Nr.
Texline (naturfarbene Leinenoptik)	A0066













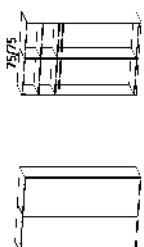
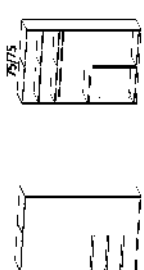
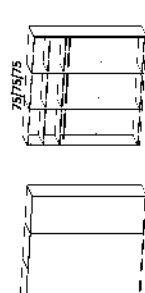
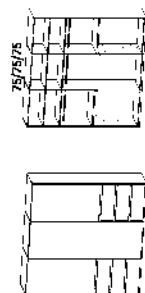

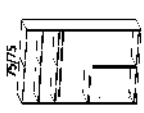
Texline

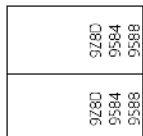
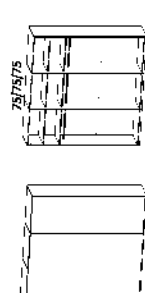
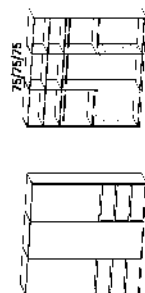
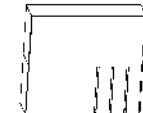
ZUBEHÖR 1.0

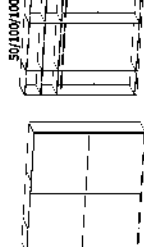
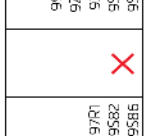
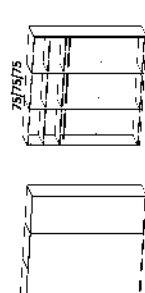
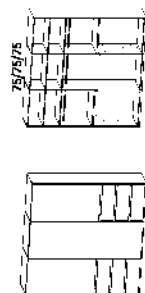
MONTIERT

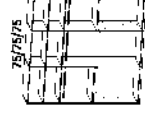
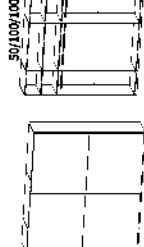
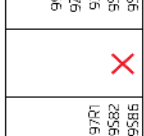
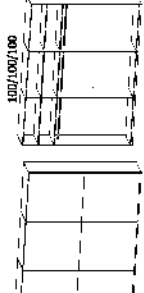
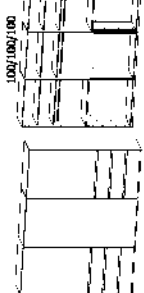
für Dreh-/Schwebetürenschränke
Elementbreite 50, 75, 100 cm

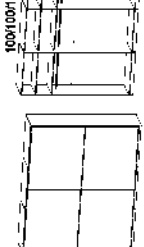
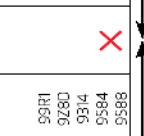
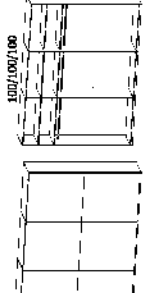
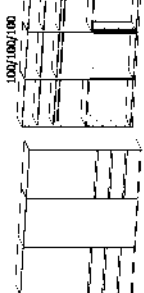
Diese Schrankbreiten bestehen aus folgenden Elementen:

	Schwebetürenschränke 2-türig	Schwebetürenschränke 3-türig	Schwebetürenschränke mit Schubkästen
↔ 151 cm	 	 	 
↔ 201 cm	 	 	 
↔ 226 cm	 	 	 
↔ 251 cm	 	 	 
↔ 301 cm	 	 	 

Einbaumöglichkeiten für Schub-
kasteneinsätze, Hosenauszüge,
Kleiderliffe und Auszugsböden in
Schwebetürenschränke

Einbaumöglichkeiten für Schub-
kasteneinsätze, Hosenauszüge,
Kleiderliffe und Auszugsböden in
Schwebetürenschränke







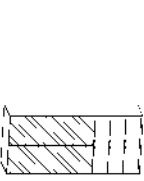
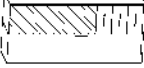

Einbaumöglichkeiten für Schub-
kasteneinsätze, Hosenauszüge,
Kleiderliffe und Auszugsböden in
Schwebetürenschränke

ZUBEHÖR 1.0

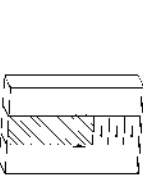
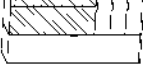
MONTIERT

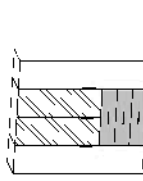
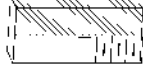
für Dreh-/Schwebetürenschränke
Elementbreite 50, 75, 100 cm

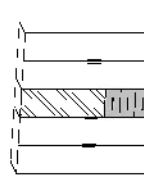
Diese Schrankbreiten bestehen aus folgenden Elementen:

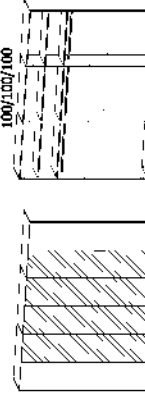
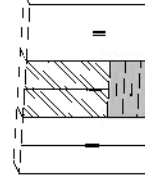
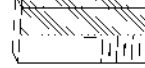



	Drehtürenschränke	Drehtürenschränke mit Schubkästen mittig	Drehtürenschränke mit Schubkästen seitlich
•• 101 cm	 100	 100	 50/50
↔ 151 cm	 100/50	 50/50/50	 50/100
↔ 201 cm	 100/100	 50/100/50	 100/100
•• 251 cm	 100/50/100	 100/50/100	 100/50/100
•• 301 cm	 100/100/100	 100/100/100	 100/100/100



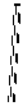

ZUBEHÖR 1.0

MONTIERT

für Dreh-/Schwebetürenschränke
Elementbreite **50, 75, 100 cm**

Farbe	Modell-Nr.
Textiline (naturfarbene Leinenoptik)	A0066

ELEMENTBREITE ▶		50	50	50		
		Fachboden für Elementbreite 50 cm ↔48 cm ↑2 cm ↙50 cm		Kleiderstange für Elementbreite 50 cm ↔48 cm ↑3 cm ↙2 cm 9739		
					Preis	9643
					2er Set	97F6
					3er Set	9633
					4er Set	99J6
	Auszugsboden für Elementbreite 50 cm ↔48 cm ↑9 cm ↙49 cm 97R1		Schubkasteneinteilung für Auszugsboden für Elementbreite 50 cm ↔36 cm ↑5 cm ↙44 cm 96T2	*		
					Preis	9739
					2er Set	97F6
					3er Set	9633
					4er Set	99J6



ELEMENTBREITE ▶		50	50	50		
		Glasboden 1 Stück für Auszugsboden für Elementbreite 50 cm ↔48 cm ↑1 cm ↙49 cm 9G5B		Schubkasteneinsatz mit 2 Schubkästen für Elementbreite 50 cm ↔48 cm ↑45 cm ↙50 cm 9S82		
					Preis	9643
					2er Set	97F6
					3er Set	9633
					4er Set	99J6
	Schubkasteneinsatz mit 3 Schubkästen für Elementbreite 50 cm ↔48 cm ↑64 cm ↙50 cm 9S86		Schubkasteneinsatz für Auszugsboden für Elementbreite 50 cm ↔48 cm ↑9 cm ↙49 cm 97R1	*		
					Preis	9643
					2er Set	97F6
					3er Set	9633
					4er Set	99J6

* Achtung: Bitte unbedingt die Einbaumöglichkeiten in Schwebetürenschränke beachten.

ZUBEHÖR 1.0

MONTIERT

für Dreh-/Schwebetürenschränke
Elementbreite 50, 75, 100 cm

Farbe		Modell-Nr.
Textiline (naturfarbene Leinwandoptik)		A0066
ELEMENTBREITE ▶		75
		
Fachboden 1 Stück für Elementbreite 75 cm ↔ 73 cm ± 2 cm ↗ 50 cm		Kleiderstange für Elementbreite 75 cm ↔ 73 cm ± 3 cm ↗ 2 cm
1 Stück	Preis	97K0
2er Set		96F2
3er Set		96F3
4er Set		96F4

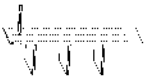
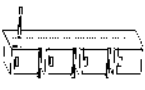
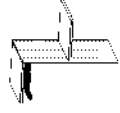
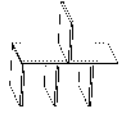
ELEMENTBREITE ▶		75	75	75	75
links + rechts montierbar					
Inneneinteilung		Inneneinteilung	Inneneinteilung	Inneneinteilung	Inneneinteilung
für Elementbreite 75cm mit Kleiderstange mit 3 Fachböden ↔ 73 cm ± 148 cm ↗ 51 cm		für Elementbreite 75cm incl. 4 Stoffkisten ↔ 73 cm ± 148 cm ↗ 51 cm	für Elementbreite 75cm mit Hosenhalter ↔ 73 cm ± 80 cm ↗ 51 cm	für Elementbreite 75cm mit 4 Fachböden ↔ 73 cm ± 180 cm ↗ 51 cm	
Artikel	Preis	99J4	99S7	99H7	99K7

NEU

LIEFERBAR AB 06/2022

NEU

LIEFERBAR AB 06/2022

NEU

LIEFERBAR AB 06/2022



NEU

LIEFERBAR AB 06/2022



ZUBEHÖR 1.0

MONTIERT

für Dreh-/Schwebetürenschränke
Elementbreite 50, 75, **100** cm

		<table border="1"> <tr> <td>Farbe</td> <td>Modell-Nr.</td> </tr> <tr> <td>Textilne (naturfarbene Leinenoptik)</td> <td>A0066</td> </tr> </table>		Farbe	Modell-Nr.	Textilne (naturfarbene Leinenoptik)	A0066
Farbe	Modell-Nr.						
Textilne (naturfarbene Leinenoptik)	A0066						
ELEMENTBREITE ▶ 100		100					
 <p>Fachböden für Elementbreite 100cm → 98 cm ↑ 2 cm ↘ 50 cm</p>		 <p>Kleiderstange für Elementbreite 100cm → 98 cm ↑ 3 cm ↘ 2 cm</p>					
1 Stück	Preis	9641					
2er Set		97F9					
3er Set		9631					
4er Set		99J9					

* Achtung: Bitte unbedingt die Einbaumöglichkeiten in Schwebetürenschränke beachten.

ELEMENTBREITE ▶ 100		100	
 <p>Auszugsboden für Elementbreite 100cm → 98 cm → 9 cm ↘ 49 cm</p>		 <p>Schubkasteneinteilung für Auszugsboden für Elementbreite 100cm → 86 cm ↑ 5 cm ↘ 44 cm</p>	
		99R1	
		96T4	

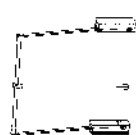
ELEMENTBREITE ▶ 100		100	
 <p>Glasboden 1 Stück für Auszugsboden für Elementbreite 100cm → 98 cm ↑ 1 cm ↘ 49 cm</p>		 <p>Kleiderlift → 98 cm → 84 cm ↘ 14 cm</p>	
		965D	
		928D	
Artikel	Preis		

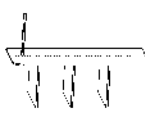
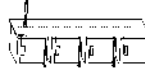
ELEMENTBREITE ▶ 100		100	
 <p>Inneneinteilung mit 3 Fachböden mit Kleiderstange für Elementbreite 100cm → 98 cm ↑ 148 cm ↘ 51 cm</p>		 <p>Inneneinteilung für Elementbreite 100cm ind. 4 Stoffkisten → 98 cm ↑ 148 cm ↘ 51 cm</p>	
		9SJ6	
		92S0	
Artikel	Preis		

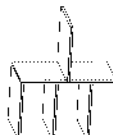

ELEMENTBREITE ▶ 100		100	
 <p>Inneneinteilung für Elementbreite 100cm mit Hosenhalter → 98 cm → 80 cm ↘ 51 cm</p>		 <p>Inneneinteilung für Elementbreite 100cm mit 4 Fachböden → 98 cm → 80 cm ↘ 51 cm</p>	
		92H0	
		92K0	
Artikel	Preis		





ZUBEHÖR 1.0

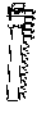



MONTIERT

Allgemein

Farbe	Modell-Nr.
Textiline (naturfarbene Leinenoptik)	A0066

ALLGEMEIN	
	
Krawattenhalter schwenkbar ••32 cm •27 cm •*6 cm 9768	Krawatten-/Gürtelhalter ••10 cm •13 cm •46 cm 990K
	
Krawattenhalter ausziehbar ••9 cm •6 cm •45 cm 9GK1	Kleiderbügelhalter ••31 cm •6 cm •4 cm 9760
Artikel	Preis

ALLGEMEIN	
	
Hakenleiste ••35 cm •5 cm •5 cm 9HL1	Hosenhalter ••25 cm •7 cm •46 cm 990H
	
Garderobenhalter ••7 cm •52 cm •28 cm 9767	Garderobenhalter schwenkbar ••20 cm •35 cm •3 cm 9769
Artikel	Preis

ALLGEMEIN	
	
Montierbar nur an Außenseiten und der mittl. Seite. Max. Belastung je Korb 11 kg.	Montierbar nur an Außenseiten und der mittl. Seite. Max. Belastung je Schuh-Ablage 4 kg.
Metallkörbe 3er Set ••35 cm •62 cm •50 cm 9AZ5	Schuhablagen 3er Set ••26 cm •66 cm •50 cm 9AZ6
	
Max. Belastung 7 kg.	Wäschekorb mit Auszug ••30 cm •55 cm •50 cm 9WK1
Artikel	Preis

ZUBEHÖR 1.0

MONTIERT

Allgemein

Farbe	Modell-Nr.
Textiline (naturfarbene Leinenoptik)	A0066

ALLGEMEIN			
	Innenspiegel für Drehtüren → 29 cm × 130 cm × 4 cm 98S8	Innenspiegel , für Schwebetüren Spiegelbreite 31cm drehbar ausziehbar von 45cm auf 73cm → 46 cm × 115 cm × 4 cm 9408	
Artikel	Preis		

ALLGEMEIN		Türendämpfer rauch EASY SLIDE	
		Schwebetürendämpfer 2er Set EASY SLIDE für 2- bis 4-trg. Schwebetürendränke → 61 cm × 28 cm × 4 cm 9DM1	Mitteltürendämpfer EASY SLIDE für 3-1trg. Schwebetürendränke → 28 cm × 2 cm × 4 cm 9DM4
Artikel	Preis		







BELEUCHTUNG			
	Innenbeleuchtung mit Bewegungsmelder LED-Leuchte → 23 cm × 2 cm × 11 cm 9T1B	Mitteltürendämpfer EASY SLIDE für 3-1trg. Schwebetürendränke → 28 cm × 2 cm × 4 cm 9DM4	Kollisionsdämpfer EASY SLIDE für 2-1trg. Schwebetürendränke → 14 cm × 19 cm × 2 cm 9DM6
Artikel	Preis		







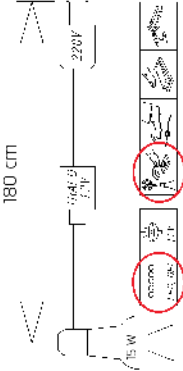

ZUBEHÖR 1.0









MONTIERT

Allgemein

Farbe	Modell-Nr.
Textiline (naturfarbene Leinwandoptik)	A0066

BELEUCHTUNG		BALENO		
				
				
		LED-Bügelleuchte	LED-Bügelleuchte	
Artikel	Preis	••90 cm •6 cm √19 cm	••90 cm •6 cm √19 cm	
		9W1L	9S1L	
 <p>Dieses Produkt enthält eine Lichtquelle der Energieeffizienzklasse E.</p> <p>EPREL 7668436</p>				

BELEUCHTUNG		LUCIDO	NEELA	LUNA	LOFT
					
					
		LED-Leuchte 2er Set	LED-Leuchte 2er Set	LED-Leuchte 2er Set	LED-Leuchte 2er Set
2er Set	Preis	••27 cm •7 cm √14 cm	••89 cm •6 cm √18 cm	••21 cm •19 cm √33 cm	••33 cm •15 cm √18 cm
		9L42	9L62	94L2	9C74
3er Set		9L43		94L3	9C76
<p>Alu</p>					

BELEUCHTUNG		LUCIDO	NEELA	LUNA	LOFT
					
					
		LED-Leuchte 2er Set	LED-Leuchte 2er Set	LED-Leuchte 2er Set	LED-Leuchte 2er Set
2er Set	Preis	••590 cm	••750 cm	••530 cm	••580 cm
		936418	766774	766798	766530
<p>Dieses Produkt enthält eine Lichtquelle der Energieeffizienzklasse F.</p> <p>Dieses Produkt enthält eine Lichtquelle der Energieeffizienzklasse E.</p> <p>Dieses Produkt enthält eine Lichtquelle der Energieeffizienzklasse E.</p> <p>Dieses Produkt enthält eine Lichtquelle der Energieeffizienzklasse G.</p> <p>EPREL 936418</p> <p>EPREL 766774</p> <p>EPREL 766798</p> <p>EPREL 766530</p>					